

MARAZZI

TILE & STONE

2014
Sales Service Center Price Catalog

Table of Contents

Floor and Wall Applications	Page #	Architectural Tile Solutions	Page #	Decorative Tile Series	Page #
Aida	3	Sistem A	85	Catwalk	15
American Estates	4	Sistem C Architettura	6	Crystal Stone	22
Archaeology	5	Sistem C Citta	10	Crystal Stone II	23
Arctic Bay	7	Sistem T Cromie	21	Divine Woods	25
Artea Stone	8	Evolution Stone	52	Dorset Collection Cast Stone	26
Boardwalk	11	Sistem T Graniti	54	Dorset Cast Metal Decoratives	27
Calabria	12	Sistem T Kaleidos	63	Dorset Cast Metal Mosaics	28
Cambridge Oak	13	Monolith	67	Dorset Collection Tumbled Marble	29
Campione	14	Sistem N	86	Dorset Collection Minted Metals	30
Celtic Flare	16	Treverk	99	Dorset Collection Stone Shadow	31
Cimmaron	17			Dorset Collection Accessories	32
Cleftstone	19			Duratile Agglomerate	34-35
The Cliffs	20			Duratile Glass	36-37
Coliseum	24	Stone		Duratile Granite, Pebble Stone	38
Dunes	33	Turkish Travertine		Duratile Hand Made Ceramic	39
Eclipse	50	Natural Stone (BAB) A-C	103	Duratile Marble	40-42
Essentials	51	Natural Stone (BAB) D-Q	104	Duratile Metal	43
Forest Impressions	53	Natural Stone (BAB) Roman Blend	105	Duratile Quartzite, Sandstone, Travertine	44
Habitat	55	Natural Stone (BAB) Scabas	106	Duratile Slate	45-47
Harmony	56	Natural Stone (BAB) S-Z / Accessories	107	Duratile Shell, Steel, Trini	48
I Colori	57	Mexican Travertine		Duratile Stone & Glass Mix	49
I Porfidi de Marazzi	58	Natural Stone (MIC)	108	Metal Mania	66
Imperial Slate	59	Natural Stone (MIC Mesh)	109	Romance Inserts	79
India	60	Natural Stone (MIC 3)	110	Romance Liners	80
Jade	61	Natural Stone (MIC 4)	111	Romancing the Stone	81
Just	62	Natural Stone (MIC Liners)	112	Studio M	92
Lastricato	64	Natural Stone (MIC Listels)	113		
Lifestyle	65	Indian Slate		Accessories	
Mountain Lodge	68	Slate (AAT)	114	Bath Accessories	9-10
Oxford	69			EBBE Drains	115
Pavers	70	Setting Materials			
Perseo	71	Laticrete	116-118		
Province	72	Laticrete Grout	119		
Pure	73	Laticrete Grout Colors	120		
Quarry	74	Setting Materials (COM, PWC, TXI)	121		
Rapture	75	Mapei	122-124		
Revision	76	Mapei Grout	125	Locations	129
Riflessi di Legno	77	Backer Boards	126	Terms & Conditions	130
Rocca	78	Cleaners & Sealers	127-128		
Saturnia	82				
Sierra Madre	83				
Silk	84				
Soho	87				
Solaris	88				
Stone Age	89				
Stone Collection	90				
Stone Collection Deco & Trim	91				
Sumatra	93				
Super Saltillo	94				
Taiga	95				
Terra Plana	96				
Timeless	97				
Tosca	98				
Vesale Stone	100				
Walnut Canyon	101				
Western Stone	102				

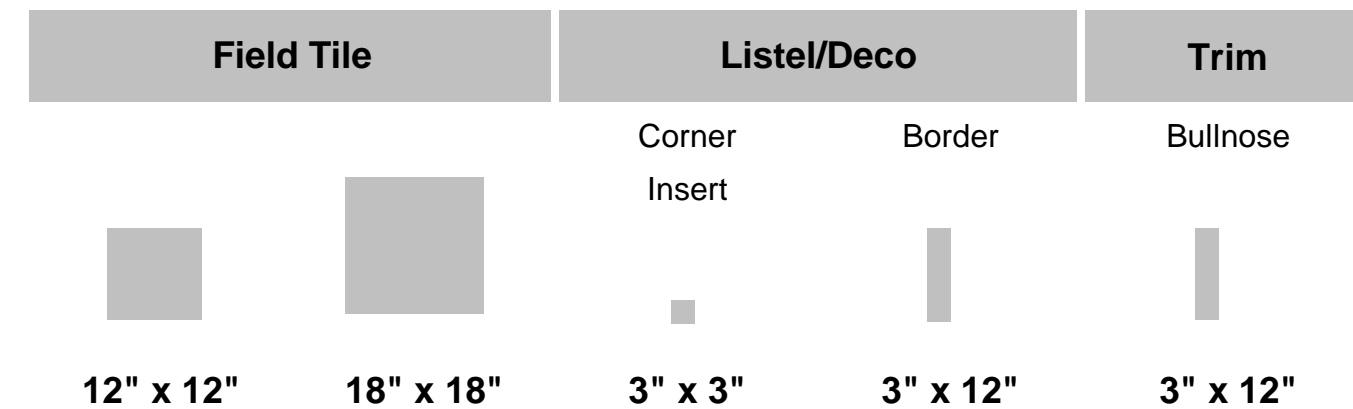

PRODUCTS, SIZES, CODES & PRICING

NAMES (colors)					
Beige/Gray (beige/gray)	UF4S	UF4W			UH5Z
Brown (brown)	UF4T	UF4X			UH52
Gold (gold)	UF4U	UF4Y			UH53
Off White (off white)	UF4V	UF4Z			UH54
Tebe Beige/Gray			UC2N	UF46	
Tebe Brown/Gold			UC2P	UF47	
Tebe Off White			UC2Q	UF48	
PRICING	sq. ft.	sq. ft.	pc	pc	pc
	\$3.10	\$3.30	\$7.98	\$16.12	\$5.52

WEIGHTS, QUANTITIES & DIMENSIONS

WEIGHTS					
Carton (lbs.)	50	63	2	6	21
Pallet (lbs.)	2400	2016			
QUANTITIES					
Tile per Carton	15	7	6	6	20
Cartons per Pallet	48	32			
DIMENSIONS					
One Carton (sq. ft.)	14.53	15.26			
One Pallet (sq. ft.)	697.44	488.32			

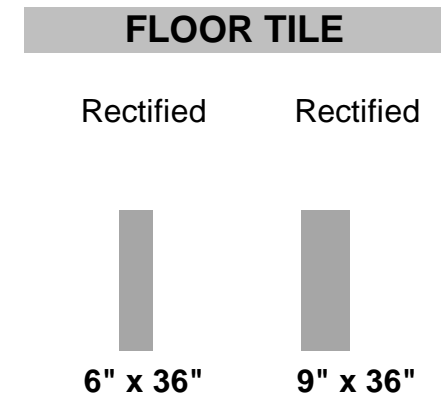

PRODUCTS, SIZES, CODES & PRICING

NAMES (colors)		
Natural (Light)	ULCD	ULCG
Saddle (Medium)	ULCE	ULCH
Spice (Dark)	ULCF	ULCJ
PRICING		
	sq. ft.	sq. ft.
	\$8.16	\$7.68

WEIGHTS, QUANTITIES & DIMENSIONS

WEIGHTS		
Carton (lbs.)	63	63
Pallet (lbs.)	2512	2268
QUANTITIES		
Tile per Carton	9	6
Cartons per Pallet	39	36
DIMENSIONS		
One Carton (sq. ft.)	12.75	13.01
One Pallet (sq. ft.)	497.25	468.36

Florence, AL

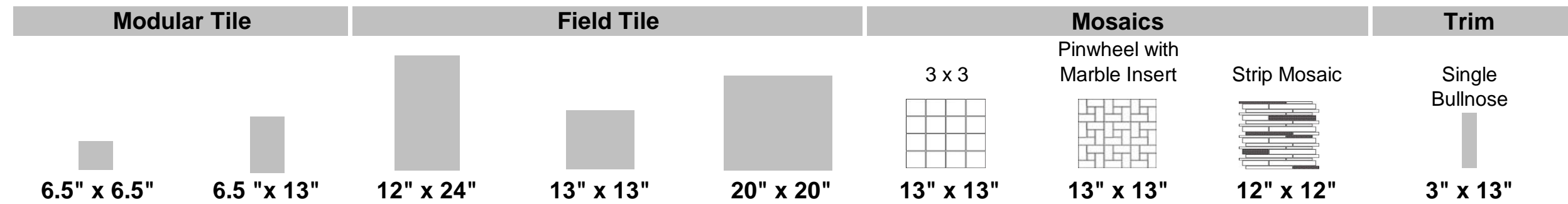

PRODUCTS, SIZES, CODES & PRICING





NAMES (colors)									
Babylon (cream)	UL2J	UL2E	UL22	UL2A	UL26	UL2W	UL32	UL36	UL2S
Chaco Canyon (amber)	UL2K	UL2F	UL23	UL2B	UL27	UL2X	UL33	UL37	UL2T
Crystal River (silver)	UL2L	UL2G	UL24	UL2C	UL28	UL2Y	UL34	UL38	UL2U
Troy (walnut)	UL2M	UL2H	UL25	UL2D	UL29	UL2Z	UL35	UL39	UL2V
PRICING	sq. ft.	sq. ft.	sq. ft.	sq. ft.	sq. ft.	pc	pc	pc	pc
	\$5.96	\$5.96	\$6.08	\$5.74	\$5.96	\$21.52	\$27.46	\$41.80	\$5.82

WEIGHTS, QUANTITIES & DIMENSIONS

WEIGHTS									
Carton (lbs.)	42	42	50	73	79	39	39	39	21
Pallet (lbs.)	2142	2142	2000	2774	1896				
QUANTITIES									
Tile per Carton	32	16	5	13	6	10	10	10	20
Cartons per Pallet	51	51	40	38	24				
DIMENSIONS									
One Carton (sq. ft.)	9.38	9.46	9.69	15.52	16.15	11.94	11.94	9.69	
One Pallet (sq. ft.)	478.38	482.46	387.60	589.76	387.60				

Florence, AL



WALL TILE ¹			DECORATIVE OPTIONS ¹
 4" x 4" (10 x 10 cm)	 8" x 8" (20 x 20 cm)	 4" x 12" (10 x 30 cm)	Dimensional Insert  4" x 12" (10 x 30 cm)

PRODUCTS, SIZES, CODES & PRICING

LEVEL 1	NAMES (colors)				
	ARCH_Bianco	ME90	ME83	KYWU	MJAX
	ARCH_Cemento	ME9X	ME80	KYWX	MJ7V
	ARCH_Avorio	ME9V	ME8Y	KYWY	MJB1
	ARCH_Tortora			MJ0D	MJB2
	ARCH_Nero	ME9W	ME8Z	KYWV	MJB0
	ARCH_Grigio	ME9Y	ME81		
	ARCH_Perla	ME9U	ME8X		
PRICING	sq. ft.	sq. ft.	sq. ft.	sq. ft.	
	\$4.82	\$4.18	\$5.74	\$6.18	

LEVEL 2	NAMES (colors)				
	ARCH_Ametista			MJ0H	MJB6
	ARCH_Ocra	ME84	ME77		
	ARCH_Rosso		MJ29		
	ARCH_Ambra	ME88	ME8C		
	ARCH_Turchese		MJ2C		
	ARCH_Giada		ME8N		
	ARCH_Aqua		MJ2E		
	ARCH_Blu		MJ2B		
	ARCH_Cobalto			MJ0J	MJB5
PRICING	sq. ft.	sq. ft.	sq. ft.	sq. ft.	
	\$5.14	\$4.42	\$6.30	\$6.74	

WEIGHTS, QUANTITIES & DIMENSIONS

WEIGHTS				
Carton (lbs.)	30	42	37	27
Pallet (lbs.)	2182	3220	2508	1966
QUANTITIES				
Tile per Carton	100	40	36	26
Cartons per Pallet	72	75	66	72
DIMENSIONS				
One Carton (sq. ft.)	10.76	17.22	11.63	8.40
One Pallet (sq. ft.)	774.72	1291.50	767.58	604.80

Sunnyvale, TX

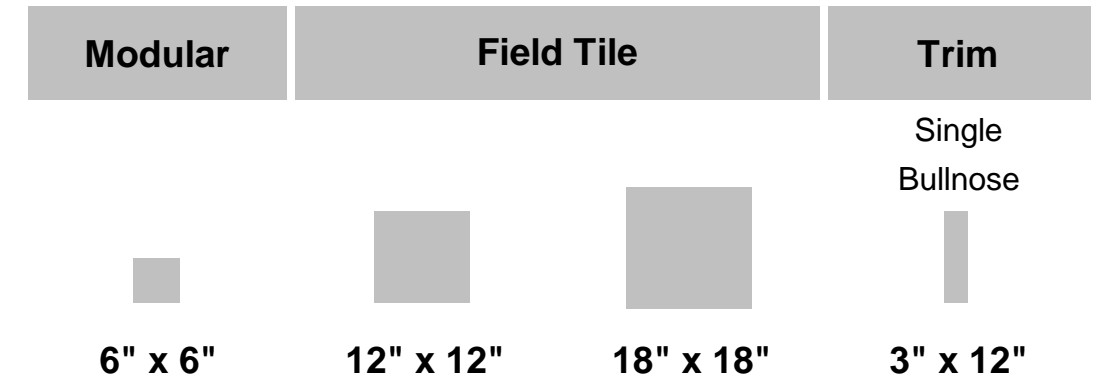

PRODUCTS, SIZES, CODES & PRICING

NAMES (colors)				
Arviat (taupe)	UG5C	UG5F	UG5J	UG5M
Grise (gold)	UG5D	UG5G	UG5K	UG5N
Rankin (noce)	UG5E	UG5H	UG5L	UG5P
PRICING	sq. ft.	sq. ft.	sq. ft.	pc
	\$4.26	\$2.28	\$2.60	\$4.26

WEIGHTS, QUANTITIES & DIMENSIONS

WEIGHTS				
Carton (lbs.)	35	50	63	21
Pallet (lbs.)	2800	2400	2016	
QUANTITIES				
Tile per Carton	40	15	7	20
Cartons per Pallet	80	48	32	
DIMENSIONS				
One Carton (sq. ft.)	9.69	14.53	15.26	
One Pallet (sq. ft.)	775.20	697.44	488.32	

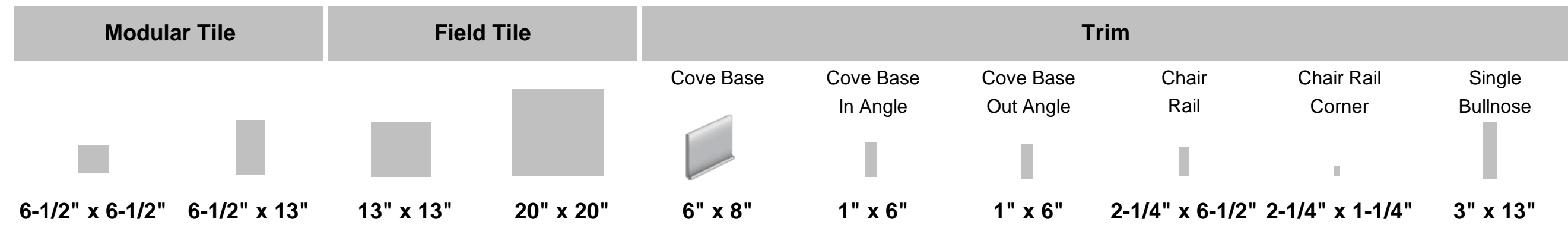

PRODUCTS, SIZES, CODES & PRICING

NAMES (colors)										
Artea Antico (light taupe)	UC43 N2	UC48 N2	UC4D N2	UC4J	UD1M	UD1S	UD1X	UC4W	UC53	UC4R
Artea Avorio (ivory)	UC44 N2	UC49 N2	UC4E N2	UC4K	UD1N	UD1T	UD1Y	UC4X	UC54	UC4S
Artea Cappuccino (cocoa)	UC42 N2	UC47 N2	UC4C N2	UC4H	UD1P	UD1U	UD1Z	UC4V	UC52	UC4Q
Artea Noce (brown)	UC3Z N2	UC46 N2	UC4B N2	UC4G	UD1Q	UD1V	UD20	UC4U	UC4Z	UC4P
Artea Oro (gold)	UC3Y N2	UC45 N2	UC4A N2	UC4F	UD1R	UD1W	UD21	UC4T	UC4Y	UC4N
PRICING	sq. ft.	sq. ft.	sq. ft.	sq. ft.	pc	pc	pc	pc	pc	pc
	\$4.10	\$4.10	\$3.78	\$4.20	\$9.18	\$10.50	\$10.50	\$4.84	\$6.10	\$3.68

WEIGHTS, QUANTITIES & DIMENSIONS

WEIGHTS										
Carton (lbs.)	42	42	73	79	26	2	2	4	1	18
Pallet (lbs.)	2142	2142	2774	1896						
QUANTITIES										
Tile per Carton	36	18	15	6	24	6	6	6	4	20
Cartons per Pallet	51	51	38	24						
DIMENSIONS										
One Carton (sq. ft.)	10.55	10.65	17.90	16.15						
One Pallet (sq. ft.)	538.05	543.15	380.20	387.60						

Florence, AL

COLOR	SKU	Size	PC / CT	LB / CT	Price
-------	-----	------	---------	---------	-------

PRODUCTS, SIZES, CODES & PRICING

NAMES (colors)

***SWITCH PLATES** - Cast Stone

Toggle	SW102	Single	12	2	\$ 9.40
Toggle	SW104	Double	6	1	\$ 15.80
Toggle	SW106	Triple	6	2	\$ 19.82
GFCI	SW103	Single	12	2	\$ 9.40
GFCI	SW105	Double	6	1	\$ 15.80
GFCI	SW107	Triple	6	2	\$ 19.82
Duplex	SW101	Single	12	2	\$ 9.40
Toggle/Duplex	SW108	Combo	6	1	\$ 15.80
Toggle/GFCI	SW109	Combo	6	1	\$ 15.80
Quad Toggle	SW120	8.75x5	6	3	\$ 25.20

***BATH ACCESSORIES** - Cast Stone





Portico Corner Shelf	SBA101	8"	4	13	\$ 44.04
Portico Corner Shelf Large	SBA102	10"	4	21	\$ 56.98
Portico Soap Dish	SBA103		4	7	\$ 29.10
Portico Post Set • Travertine (01) only	SBA104	Set	12	11	\$ 46.52
Portico Towel Bar • Travertine (01) only	SBA105	28"	24	7	\$ 13.92
Portico Paper Holder Set • Travertine (01) only	SBA106	Set	12	11	\$ 49.88

***Switch Plates and Bath Accessories are available in four colors.**
To order, indicate the color number and the sku. *Travertine = 01 *Noce = 02 *03 = Sand *07 = Sahara

COLOR	SKU	Size	PC / CT	LB / CT	Price
-------	-----	------	---------	---------	-------

PRODUCTS, SIZES, CODES & PRICING

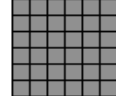
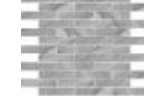
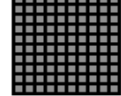
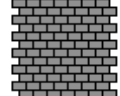
NAMES (colors)					
Corner Caddy - Ceramic	Bone	1040T		6	15 \$ 11.00
Corner Caddy - Ceramic	White	1040T		6	15 \$ 11.00
Corner Caddy Large - Ceramic	White	1050T		8	34 \$ 5.88
Corner Shelf Large - Travertine	Noce	NOCE LSHELF		6	32 \$ 41.74
Corner Shelf Large - Travertine	Medium	MD LSHELF		6	32 \$ 41.74
Corner Shelf Large - Travertine	Cream	CR LSHELF		6	32 \$ 41.74
Corner Shelf Large - Travertine	Dark	DK LSHELF	8.25x8.25	1	6 \$ 41.74
Corner Shelf Large - Travertine	Medium	MD LSHELF	8.25x8.25	1	6 \$ 41.74
Corner Shelf Large - Travertine	Light	LT LSHELF	8.25x8.25	1	6 \$ 41.74
Corner Shelf Large - Travertine	Noce	SHN LSHELF	8x1.5	6	15 \$ 28.00
Corner Shelf Large - Travertine	Ivory	SHI LSHELF	8x1.5	6	15 \$ 28.00
Towel Bar - 2 PC/SET - Ceramic	Bone	1030T		24	52 \$ 6.00
Towel Bar - 2 PC/SET - Ceramic	White	1030T		24	52 \$ 6.00
Towel Bar - 3 PC/SET - Travertine	Noce	NOCE TOWELBAR		10	27 \$ 23.10
Towel Bar - 3 PC/SET - Travertine	Medium	MD TOWELBAR		10	27 \$ 23.10
Towel Bar - 3 PC/SET - Travertine	Cream	CR TOWELBAR		10	27 \$ 23.10
Towel Bar w/ Post - Travertine	Dark	DK TOWELBAR	5x8	1	3 \$ 23.10
Towel Bar - 3 PC/SET w/ 24" Bar - Travertine	Noce	SHN TOWELBAR	5x3x3.5	10	11 \$ 22.00
Towel Bar - 3 PC/SET w/ 24" Bar - Travertine	Ivory	SHI TOWELBAR	5x3x3.5	10	11 \$ 22.00
Soap Dish - Ceramic	Bone	1010T		10	21 \$ 5.00
Soap Dish - Ceramic	White	1010T		10	21 \$ 5.00
Soap Dish w/ Washcloth Holder - Ceramic	Bone	5015T		9	21 \$ 5.52
Soap Dish w/ Washcloth Holder - Ceramic	White	5015T		9	21 \$ 6.00
Soap Dish - Travertine	Noce	NOCE SOAPDISH		10	30 \$ 23.10
Soap Dish - Travertine	Medium	MD SOAPDISH		10	30 \$ 23.10
Soap Dish - Travertine	Cream	CR SOAPDISH		10	30 \$ 23.10
Soap Dish - Travertine	Dark	DK SOAPDISH	5x8	1	3 \$ 23.10
Soap Dish - Travertine	Light	LT SOAPDISH	5x8	1	3 \$ 23.10
Soap Dish - Travertine	Noce	SHN SOAPDISH	8.5x5.35	10	12 \$ 22.00
Soap Dish - Travertine	Ivory	SHI SOAPDISH	8.5x5.35	10	12 \$ 22.00
Paper Holder - Ceramic	White	1020T		10	17 \$ 4.80

Modular	Field Tile			Mesh Mosaics				Trim
								
3-1/4" x 6-1/2"	13" x 13"	20" x 20"	13" x 13"	13" x 13"	13" x 13"	13" x 13"	3" x 13"	

PRODUCTS, SIZES, CODES & PRICING

NAMES (colors)

Beige	AJ4Y	AJ38	AJ4B	AJ53	AJ56			AJ4L
Gray	AJ4Z	AJ39	AJ4C	AJ54	AJ57			AJ4M
Multi	AJ52	AJ4A	AJ4D	AJ55	AJ58			AJ4N
Studio M Jive Glass Mosaic						UJ99	UJAF	

PRICING

	sq. ft.	sq. ft.	sq. ft.	sq. ft.	sq. ft.	sq. ft.	sq. ft.	pc
	\$6.14	\$3.78	\$4.20	\$20.48	\$25.26	\$20.48	\$20.48	\$5.68

WEIGHTS, QUANTITIES & DIMENSIONS

WEIGHTS

Carton (lbs.)	42	62	79	39	39	29	29	21
Pallet (lbs.)	2142	2728	1896					

QUANTITIES

Tiles per Carton	72	13	6	10	10	10	10	20
Cartons per Pallet	51	44	24					

DIMENSIONS

One Carton (sq. ft.)	10.55	15.52	16.15	11.93	11.94	11.50	11.50	
One Pallet (sq. ft.)	538.05	682.88	387.60					

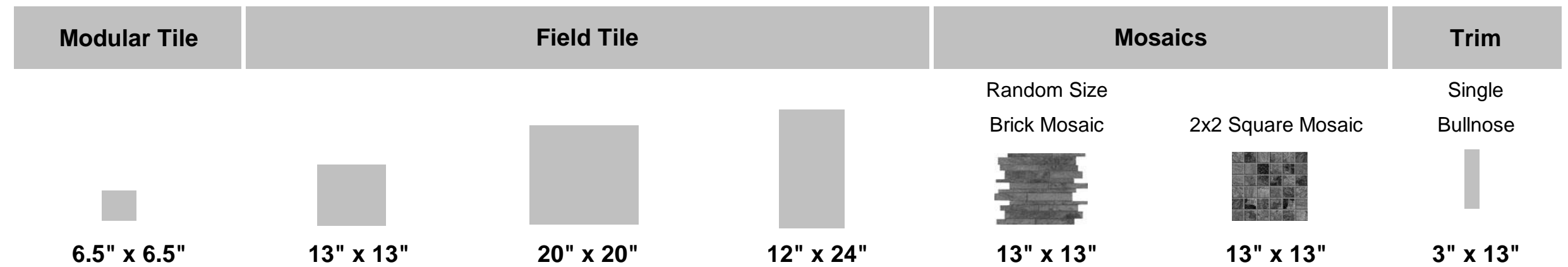

PRODUCTS, SIZES, CODES & PRICING

NAMES (colors)							
Bianco (white)	AK3V	AK3L	AK3P	AK3S	AK36	AK33	AK3Y
Blue	AK3U	AK3K	AK3N	AK3R	AK35	AK32	AK3X
Brown	AK3T	AK3J	AK3M	AK3Q	AK34	AK3Z	AK3W
PRICING	sq. ft.	sq. ft.	sq. ft.	sq. ft.	sq. ft.	sq. ft.	pc
	\$6.46	\$5.98	\$5.98	\$6.78	\$27.56	\$23.16	\$5.96

WEIGHTS, QUANTITIES & DIMENSIONS

WEIGHTS							
Carton (lbs.)	42	62	79	50	46	39	21
Pallet (lbs.)	2142	2728	1896	2000			
QUANTITIES							
Tile per Carton	36	13	6	5	9	10	20
Cartons per Pallet	51	44	24	40			
DIMENSIONS							
One Carton (sq. ft.)	10.55	15.52	16.15	9.69			
One Pallet (sq. ft.)	538.05	682.88	387.60	387.60			

FLOOR TILE

Rectified Rectified

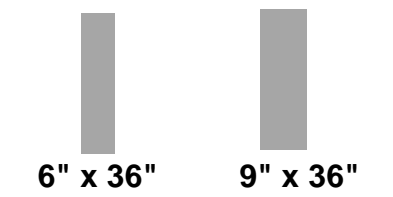

PRODUCTS, SIZES, CODES & PRICING

NAMES (colors)		
Black	AL6P	AL6S
Brown	AL6Q	AL6T
Natural	AL6R	AL6U
PRICING		
	sq. ft.	sq. ft.
	\$8.16	\$7.68

WEIGHTS, QUANTITIES & DIMENSIONS

WEIGHTS		
Carton (lbs.)	63	63
Pallet (lbs.)	2512	2268
QUANTITIES		
Tile per Carton	9	6
Cartons per Pallet	39	36
DIMENSIONS		
One Carton (sq. ft.)	12.75	13.01
One Pallet (sq. ft.)	497.25	468.36

Florence, AL

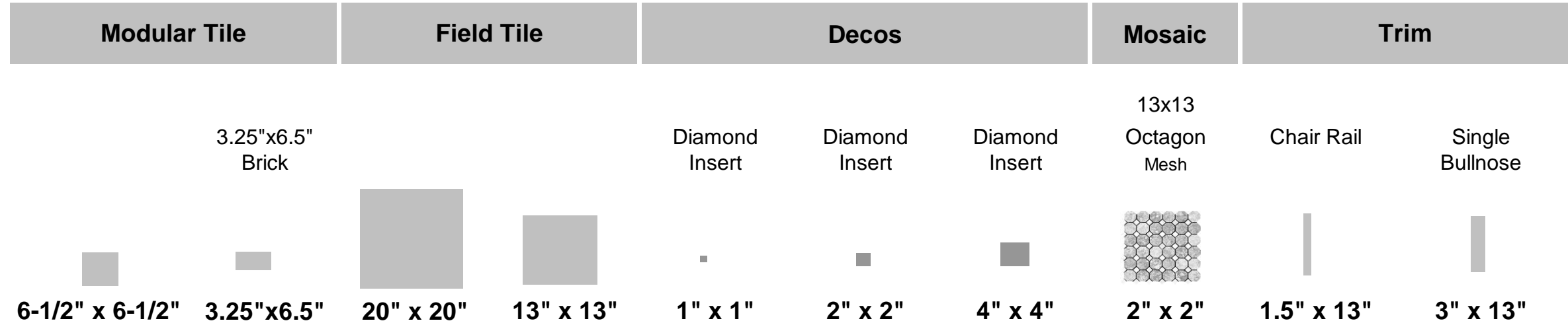

PRODUCTS, SIZES, CODES & PRICING

NAMES (colors)

Andretti (dark brown)	UJ28	UJ3B	UHAS	UHAN				UHA6		UHA2
Armstrong (beige)	UJ29	UJ3C	UHAT	UHAP				UHA7		UHA3
Sampras (light brown/gray)	UJ3A	UJ3D	UHAU	UHAQ				UHA8		UHA4
Romance Bronze					UJ67	UJ65	UJ63		UJ6P	
Romance Nickel					UJ66	UJ64	UJ62		UJ6N	

PRICING	sq. ft.	sq. ft.	sq. ft.	sq. ft.	pc	pc	pc	pc	pc	pc
	\$5.64	\$5.84	\$4.20	\$3.78	\$3.62	\$4.76	\$13.08	\$31.34	\$15.60	\$5.80

WEIGHTS, QUANTITIES & DIMENSIONS

WEIGHTS

Carton (lbs.)	42	42	79	73	1	1	2	39	8	21
Pallet (lbs.)	2142	2142	1896	2774						

QUANTITIES

Tile per Carton	36	72	6	15	10	8	8	10	10	20
Cartons per Pallet	51	51	24	38						

DIMENSIONS

One Carton (sq. ft.)	10.55	10.55	16.15	17.91				11.94		5.74
One Pallet (sq. ft.)	538.05	538.05	387.60	680.58						

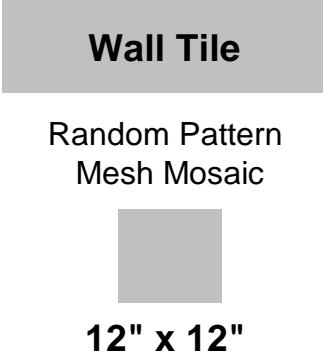

PRODUCTS, SIZES, CODES & PRICING

NAMES (colors)	
Blue Ballet	UJ9S
Chocolate Clog	UJ9T
Jade Jellies	UJ9U
Olive Oxfords	UJ9V
Pecan Pump	UJ9W
Sable Slipper	UJ9Y
Smokey Stiletto	UJ9X
Steel Toe	UJ9Z
Toffee Tennies	UJ92
Walnut Wedge	UJ93
PRICING	sq.ft.
	\$47.10

WEIGHTS, QUANTITIES & DIMENSIONS

WEIGHTS	
Carton (lbs.)	1.25
QUANTITIES	
Tile per Carton	1
DIMENSIONS	
One Carton (sq. ft.)	1

All colors are non-stock / special order. Please allow 3 - 5 days for delivery.

Sunnyvale, TX

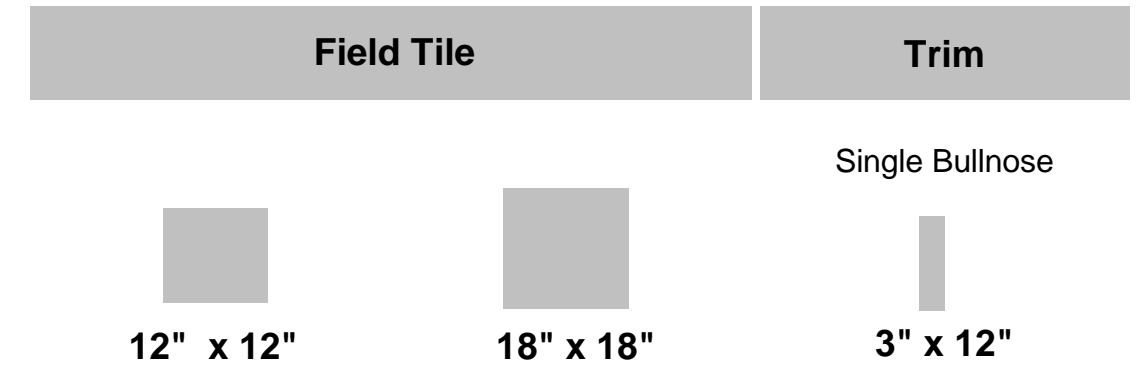

PRODUCTS, SIZES, CODES & PRICING

NAMES (colors)			
Gold	UH2R	UH2U	UH44
Beige	UH2S	UH2V	UH45
Grey	UH2T	UH2W	UH46











PRICING	sq.ft.	sq.ft.	pc
	\$2.28	\$2.60	\$5.52

WEIGHTS, QUANTITIES & DEMENSIONS

WEIGHTS			
Carton (lbs.)	50	63	21
Pallet (lbs.)	2400	2016	

QUANTITIES			
Tile per Carton	15	7	20
Cartons per Pallet	48	32	

DIMENSIONS			
One Carton (sq. ft.)	14.53	15.26	
One Pallet (sq. ft.)	697.44	488.32	

Modular	Field Tile			Listel / Deco		Trim					
				Listel	Listel Insert	Single Bullnose	Quarter Round	Quarter Round Angle	Cove Base	Cove Base In-Angle	Cove Base Out-Angle
											
6" x 6"	12" x 12"	18" x 18"		1" x 12"	1" x 1"	3" x 12"	1" x 6"	1" x 1"	6" x 8"	1" x 6"	1" x 6"

PRODUCTS, SIZES, CODES & PRICING

NAMES (colors)

Canyon (noce)	UG2X	UG33	UG37			UG3T	UG3K	UG3P	UG45	UG49	UG4D
Meadow (cream)	UG32	UG36	UG3A			UG3W	UG3N	UG3S	UG48	UG4C	UG4G
Sierra (black)	UG2Y	UG34	UG38			UG3U	UG3L	UG3Q	UG46	UG4A	UG4E
Timber (beige)	UG2Z	UG35	UG39			UG3V	UG3M	UG3R	UG47	UG4B	UG4F
Copper Strata (complements all colors)				UG43	UG44						

PRICING

sq. ft.	sq. ft.	sq. ft.	pc	pc	pc	pc	pc	pc	pc	pc
\$4.26	\$2.70	\$3.00	\$15.40	\$6.58	\$5.52	\$6.20	\$6.20	\$13.66	\$12.72	\$12.72

WEIGHTS, QUANTITIES & DIMENSIONS

WEIGHTS

Carton (lbs.)	35	50	63	2	2	21	2	1	26	2	2
Pallet (lbs.)	2800	2400	2016								

QUANTITIES

Tile per Carton	40	15	7	6	8	20	10	4	24	6	6
Cartons per Pallet	80	48	32								

DIMENSIONS

One Carton (sq. ft.)	9.69	14.53	15.26								
One Pallet (sq. ft.)	775.20	697.44	488.32								



WALL TILE ¹			DECORATIVE OPTIONS ¹			TRIM ²			
			Dimensional Insert	Square Mosaic 1"x1"	Stacked Mosaic 1"x2"	Cove Base In Angle	Cove Base Out Angle	Cove Base	Bullnose
4"x4" (10 x 10 cm)	8"x8" (20 x 20 cm)	4"x12" (10 x 30 cm)	4"x12" (10 x 30 cm)	8"x8" (20 x 20 cm)	8"x8" (20 x 20 cm)	1 3/16"x8" (3 x 20 cm)	1 3/16"x8" (3 x 20 cm)	4"x8" (10 x 20 cm)	4"x12" (10 x 30 cm)

PRODUCTS, SIZES, CODES & PRICING

LEVEL 1	NAMES (colors)									
	Agata_C		MEE9 ³	KYWR	MJ7Y					
Argilla_C		MJ1B ³								
Avorio_C	MEHD ³	MEFD ³	KYWT	MJ7X	MJ6Y ³	MJ6Z ³				ULFA
Bianco_C	MEHJ ³	MEFJ ³	KYWP	MJ7U	MJ6U ³	MJ6V ³	MURH ³	MURD ³	MURZ ³	ULF6
Cemento_C	MEHF ³	MEFF ³	KYWS	MJ7V			MDC4 ³	MDC9 ³		ULF9
Creta_C		MJ0X ³	MI0U	MJ8B						ULFB
Fango_C		MJ12 ³								
Fumo_C	MJ42 ³	MJ0P ³	MI0R							ULF8
Ghiaccio_C	MJ41 ³	MJ0N ³								
Grigio_C	MEHG ³	MEFG ³	MI0Q		MJ6W ³	MJ6X ³				ULF7
Nero_C	MEHE ³	MEFE ³	KYWQ	MJ7W	MJ72 ³	MJ73 ³				ULFL
Perla_C	MEHC ³	MEFC ³								
Sabbia_C		MJ0Y ³								
Tortora_C	MJ47 ³	MJ0Z ³	MI0T	MJ7Z	MJ70 ³	MJ71 ³				ULFC
PRICING	sq. ft.	sq. ft.	sq. ft.	sq. ft.	per piece	per piece	per piece	per piece	per piece	per piece
	\$4.82	\$4.18	\$5.74	\$6.18	\$5.36	\$5.36	\$6.18	\$6.18	\$4.98	\$5.52

LEVEL 2	NAMES (colors)									
	Ambra_C	MEGP ³	MEEP ³							
Ametista_C		MJ1S ³	MI0X	MJ9Q						ULFG
Aqua_C		MJ0U ³								
Blu_C	MJ45 ³	MJ0S ³					MJ6P ³	MJ6Q ³		
Cobalto_C	MJ44 ³	MJ0R ³	MI0Y	MJ9N						ULFK
Giada_C		MEE0 ³								
Ocra_C	MEGK ³	MEEK ³	MI0V	MJ8S						ULFE
Pistacchio_C	MJ46 ³	MJ0W ³	MJ09	MJ9B						ULFJ
Rosso_C	MJ43 ³	MJ0Q ³	MI0W	MJ9P						ULFF
Turchese_C	MJ23 ³	MJ0T ³	MI0Z	MJ9M						ULFH
Verde_C		MEE3 ³								
PRICING	sq. ft.	sq. ft.	sq. ft.	sq. ft.			per piece	per piece		per piece
	\$5.14	\$4.42	\$6.30	\$6.74	N/A	N/A	\$6.18	\$6.18	N/A	\$5.86

WEIGHTS, QUANTITIES & DIMENSIONS

WEIGHTS										
Carton (lbs.)	30	42	37	30	21	21	2	2	22	21
Pallet (lbs.)	2150	3232	2508	2188	1953	1953				
QUANTITIES										
Tile per Carton	100	37	36	29	18	18	10	10	25	20
Cartons per Pallet	72	75	66	72	93	93				
DIMENSIONS										
One Carton (sq. ft.)	10.76	15.93	11.63	9.36	7.75	7.75				
One Pallet (sq. ft.)	774.72	1194.75	767.58	673.92	720.75	720.75				

¹Due to size fluctuation, all measurements given are nominal. Where strict accuracy is required, please refer to actual tile samples.

²Available in Matte finish, used for all finishes.

³Special order only.

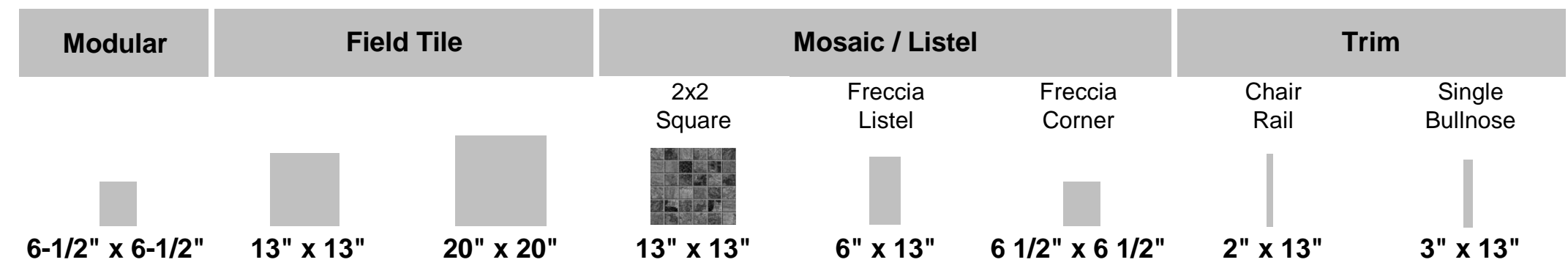

PRODUCTS, SIZES, CODES & PRICING

NAMES (colors)

Beige (Stone Sand) (PEI 5)	91T4	91S0	92D0			93N4	91S7
Bianco (Stone White) (PEI 5)	91T5	91S1	92D1			93N5	91S8
Giallo (Stone Yellow) (PEI 4)	91T2	91R8	92C8			93N3	91S5
Mountain (Stone Red) (PEI 4)	91T1	91R7	92C7	AJ4T		93N2	91S4
Nero (Stone Black) (PEI 4)	91S9	91R5	92C5	AJ4V		93N0	91S2
Verde (Stone Green) (PEI 4)	91T0	91R6	92C6	AJ4U		93N1	91S3
Red Freccia					91Z7	91Z9	
Green Freccia					91Z6	91Z8	

PRICING

sq. ft.	sq. ft.	sq. ft.	sq. ft.	pc	pc	pc	pc
\$4.10	\$3.78	\$4.20	\$20.48	\$28.48	\$21.90	\$15.76	\$5.52

WEIGHTS, QUANTITIES & DIMENSIONS

WEIGHTS

Carton (lbs.)	42	62	79	42	17	6	5	25
Pallet (lbs.)	2142	2728	1896	1890				

QUANTITIES

Tiles per Carton	36	13	6	10	6	4	6	20
Cartons per Pallet	51	44	24	45				

DIMENSIONS

One Carton (sq. ft.)	10.55	15.52	16.15	11.94				
One Pallet (sq. ft.)	538.05	682.88	387.60	537.30				

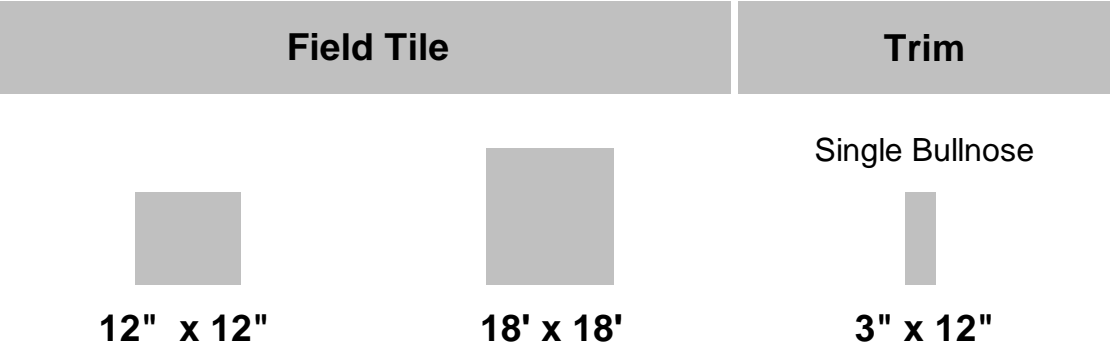

PRODUCTS, SIZES, CODES & PRICING

NAMES (colors)			
Beige	UH2Z	UH25	UH49
Black	UH2X	UH23	UH47
Brown	UH22	UH26	UH5A
Red	UH2Y	UH24	UH48
PRICING			
	sq.ft.	sq.ft.	pc
	\$2.26	\$2.60	\$5.52

WEIGHTS, QUANTITIES & DEMENSIONS

WEIGHTS			
Carton (lbs.)	50	63	21
Pallet (lbs.)	2400	2016	
QUANTITIES			
Tile per Carton	15	7	20
Cartons per Pallet	48	32	
DIMENSIONS			
One Carton (sq. ft.)	14.53	15.26	
One Pallet (sq. ft.)	697.44	488.32	



FLOOR TILE ¹										TRIMS ²			
Matte Non Rectified	Matte Non Rectified	Matte Non Rectified	Matte Rectified Double Loaded	Matte Rectified Double Loaded	Polished Non Rectified	Polished Non Rectified	Polished Rectified Double Loaded	Polished Rectified Double Loaded	Rock Rectified	Single Bullnose	Cove Base Slip	Cove Base In Angle	Cove Base Out Angle
8" x 8" (20 x 20 cm)	12" x 12" (30 x 30 cm)	16" x 16" (40 x 40 cm)	12" x 24" (30 x 60 cm)	24" x 24" (60 x 60 cm)	12" x 12" (30 x 30 cm)	16" x 16" (40 x 40 cm)	12" x 24" (30 x 60 cm)	24" x 24" (60 x 60 cm)	12" x 12" (30 x 30 cm)	4" x 12" (10 x 30 cm)	6" x 12" (15 x 30 cm)	1" x 6" (2.5 x 10 cm)	1" x 6" (2.5 x 10 cm)

PRODUCTS, SIZES, CODES & PRICING

LEVEL 1	NAMES (colors)														
	Acciaio_C		M7LQ				M7LZ					M7PY	UK3R	UK4A	UK4T
	Antracite_C (Lavagna)	MRKE ³	MRJP	MRJD ³	MJDB ³	MJBR ³	MRJQ	MRJE ³	MJDS ³	MSV0 ³	M7L7	MWKW	UK3S	UK4B	UK4U
	Cemento_C	M7MQ ³	M7LR	M7MA ³	MJBE ³	MJBQ ³	M7L0	M7ME ³	M83V ³	M7MM ³	M7L6	M7PZ	UK3X	UK4G	UK4Z
	Cotto_C (Tobacco)		MRJZ				MRK0					MWL1	UK3Y	UK4H	UK52
	Fango_C		M7LW				M7L4					M7P3	UK3Z	UK4J	UK53
	Grigio Chiaro_C (Ossidiana)		MHMM		MJBB ³	MJBM ³	MHM2		MJBG ³	MJBT ³		MJ90	UK42	UK4K	UK54
	Grigio Medio_C (Fumo)	MRKC ³	MRJM	MRJA ³	MJBC ³	MJBN ³	MRJN	MRJC ³	M83U ³	MSUZ ³	MRLG	MWKV	UK43	UK4L	UK55
	Marrone_C (Diaspro)		MHML				MHM1					MJ9Z	UK44	UK4M	UK56
	Panna_C (Opale)	MRK5 ³	MRJF	MRJG ³	MJBA ³	MJBL ³	MRJG	MRJ7 ³	M83T ³	MSUY ³	MRLF	MWKS	UK46	UK4P	UK58
Tortora_C	M7MR ³	M7LX	M7MC ³	MJBD ³	MJBP ³	M7L5	M7MF ³	M83X ³	M7MN ³	M7L8	M7P4	UK47	UK4Q	UK59	
PRICING	sq. ft.	sq. ft.	sq. ft.	sq. ft.	sq. ft.	sq. ft.	sq. ft.	sq. ft.	sq. ft.	sq. ft.	per piece	per piece	per piece	per piece	
	\$4.98	\$5.30	\$6.30	\$6.84	\$7.50	\$9.04	\$10.36	\$11.24	\$11.60	\$5.52	\$4.98	\$12.12	\$12.48	\$12.48	

LEVEL 2	NAMES (colors)														
	Ardesia_C		M7LT				M7L1					M7P0	UK3T	UK4C	UK4V
	Blu_C		M7LV				M7L3					M7P2	UK3W	UK4F	UK4Y
	Verde_C (Smeraldo)		MHMN				MHM3					MJ91	UK48	UK4R	UK5A
	Zolfo_C (Zolfo)		MRK3				MRK4					MWL3	UK49	UK4S	UK5B
PRICING	sq. ft.	sq. ft.	sq. ft.	sq. ft.	sq. ft.	sq. ft.	sq. ft.	sq. ft.	sq. ft.	sq. ft.	per piece	per piece	per piece	per piece	
	n/a	\$5.52	n/a	\$7.50	\$7.50	\$9.92	n/a	\$11.90	\$11.60	n/a	\$5.08	\$12.12	\$12.48	\$12.48	

LEVEL 3	NAMES (colors)														
	Bianco_C	M9ZX ³	MHMZ		MJB9	MJBK	MHNE		MJBF	MHN9		MJAC	UK3V	UK4E	UK4X
	Bianco Special_C		M7LP	M7L9 ³	MJB7	MJBH	M7LY	M7MD ³	M83R	M7ML		M7PX	UK3U	UK4D	UK4W
	Nero_C		M7LU		MJB8	MJBJ	M7L2		M83W	M7MP		M7P1	UK45	UK4N	UK57
	PRICING	sq. ft.	sq. ft.	sq. ft.	sq. ft.	sq. ft.	sq. ft.	sq. ft.	sq. ft.	sq. ft.	sq. ft.	per piece	per piece	per piece	per piece
	\$5.30	\$6.30	\$7.28	\$7.50	\$7.72	\$10.94	\$11.82	\$11.90	\$12.12	n/a	\$5.30	\$12.12	\$12.48	\$12.48	

WEIGHTS, QUANTITIES & DIMENSIONS

WEIGHTS														
Carton (lbs.)	48	58	62	60	77	54	55	55	77	57	37		2	2
Pallet (lbs.)	2592	2320	2976	2880	2310	2160	2640	2640	2310	2280				
QUANTITIES														
Tile per Carton	30	15	8	6	4	15	8	6	4	15	30		10	10
Cartons per Pallet	54	40	48	48	30	40	48	48	30	40				
DIMENSIONS														
One Carton (sq. ft.)	12.92	14.53	13.78	11.63	15.50	14.53	13.78	11.63	15.50	14.53				
One Pallet (sq. ft.)	697.68	581.20	661.44	558.24	465.00	581.20	661.44	558.24	465.00	581.20				

SHADE VARIATION, APPLICATIONS & TECHNICAL FEATURES

¹Due to size fluctuation, all measurements given are nominal. Where strict accuracy is required, please refer to actual tile samples.

²Available in Matte finish, used for all finishes

³Special order only.



Floor / Wall

Paper Mounted
Mesh Mosaic



12" x 12"

PRODUCTS, SIZES, CODES & PRICING

NAMES (colors)

Breeze	LG4C
Caramel	LG4B
Coffee	LG4E
Gold	LG4J
Honey	LG4H
Ivory	LG4A
Marine	LG4D
Purple	LG4G
Walnut	LG4F

PRICING

sq.ft.
\$20.00

WEIGHTS, QUANTITIES & DIMENSIONS

WEIGHTS

Carton (lbs.)	20
Pallet (lbs.)	2040

QUANTITIES

Tile per Carton	6
Cartons per Pallet	102

DIMENSIONS

One Carton (sq. ft.)	5.81
One Pallet (sq. ft.)	592.62

Sunnyvale, TX

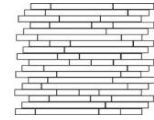
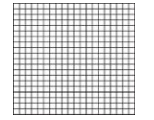
FLOOR TILE	
Strip Mosaic	Square Mosaic
	
12" x 12"	12" x 12"

PRODUCTS, SIZES, CODES & PRICING

NAMES (colors)		
Espresso	UL8Z	UL8U
Pearl	UL94	UL8X
Pewter	UL95	UL8Y
Slate	UL92	UL8V
Terracotta	UL93	UL8W
PRICING		
	sq. ft.	sq. ft.
	\$20.00	\$20.00

WEIGHTS, QUANTITIES & DIMENSIONS

WEIGHTS		
Carton (lbs.)	21	21
Pallet (lbs)	2142	2142
QUANTITIES		
Tile per Carton	6	6
Carton per Pallet	102	102
DIMENSIONS		
One Box (sq. ft.)	5.81	5.81
One Pallet (sq. ft.)	592.62	592.62

Sunnyvale, TX

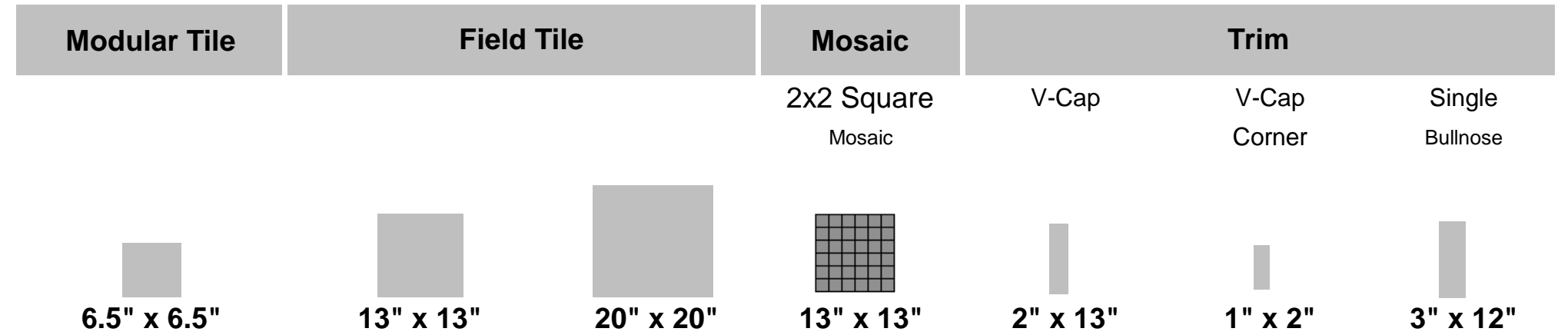





PRODUCTS, SIZES, CODES & PRICING

NAMES (colors)							
Gold	4X47	3X40	4X43	3X40 2M	3X54	3X58	4X53
Green	4X46	3X39	4X42		3X53	3X57	4X52
Ivory	3X43	3X41	3X37	3X41 2M	3X55	3X59	4X54
Walnut	3X44	3X42	3X38	3X42 2M	3X56	3X60	4X55

PRICING	sq.ft.	sq. ft.	sq. ft.	pc	pc	pc	pc
	\$4.42	\$3.78	\$4.20	\$10.74	\$8.40	\$13.48	\$5.36

WEIGHTS, QUANTITIES & DIMENSIONS

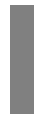
WEIGHTS							
Carton (lbs.)	43	46	80	39	9	1	20
Pallet (lbs.)	1204	2576	1920				
QUANTITIES							
Tile per Carton	32	9	6	10	6	4	20
Cartons per Pallet	28	56	24				
DIMENSIONS							
One Carton (sq. ft.)	9.38	10.74	16.15				
One Pallet (sq. ft.)	262.64	601.44	387.60				

DECOS				
Chair Rail	Pencil Liner	Bamboo Liner	Rectangle Liner	Criss-Cross Liner
				
2-1/2"x 13"	1/2"x 13"	1-5/8"x 13"	2"x 13"	2-9/16"x 13"

PRODUCTS, SIZES, CODES & PRICING

NAMES (colors)

Light Brown (medium brown)

ULL6

ULL9

ULLC

ULLF

ULLJ

Medium Brown (black brown)

ULL7

ULLA

ULLD

ULLG

ULLK

Dark Brown (red brown)

ULL8

ULLB

ULLE

ULLH

ULLL

PRICING

pc

pc

pc

pc

pc

\$16.54

\$8.28

\$16.54

\$16.54

\$16.54

WEIGHTS, QUANTITIES

WEIGHTS

Carton (lbs.)

15

4

5

13

16

QUANTITIES

Tile per Carton

11

12

10

18

15

Sunnyvale, TX

Wall Tile						Lbs/CTN	Price
2" x 2"	1/2" x 12"	3/4" x 12"	1" x 12"	2" x 12"	3" x 12"		

PRODUCTS, SIZES, CODES & PRICING

NAMES (colors)

Clover Dot	S1D108					1.7	\$ 5.82
Damask Dot	S1D204					2.1	\$ 5.82
Rope Listel	S1L200					2.8	\$ 6.70
Roper Liner			S1L101			5	\$ 8.88
Classic Liner			S1L125			5	\$ 8.88
Rope Ogee Liner			S1L103			9	\$ 12.50
Classic Ogee			S1L127			12	\$ 12.50
Laurel Border				S1L203		15.8	\$ 15.98
Soho Listel	SL400					2.9	\$ 6.12
Soho Pencil	SL401					3.7	\$ 6.70
Soho Pencil Liner			SL402			5.6	\$ 8.88
Dome Liner			S1L201			9.9	\$ 8.88
Dome Ogee			S1L202			9.9	\$ 12.50
Damask Border			S1L204			10.4	\$ 12.28

QUANTITIES

Pieces per Carton	16	12	12	12	12	12	
-------------------	----	----	----	----	----	----	--

Cast Stone is available in four colors. To order, indicate the color number and the sku. *Travertine = 01 *Noce = 02 *Sand = 03 *Sahara = 07

Wall Tile							Lbs/Ctn	Price
2" x 2"	4" x 4"	3/4" x 12"	1/2" x 12"	1" x 12"	2" x 12"	3" x 12"		

PRODUCTS, SIZES, CODES & PRICING

NAMES (colors)								
Clover Dot			M1D2100					2 \$ 8.88
Demask Dot			M1D2110					2 \$ 8.88
Soho Field			MD4030					4.6 \$ 6.90
Clover Deco			M1D2130					5.3 \$ 16.72
Soho Pencil Liner			ML4020					4.6 \$ 11.08
Rope Listel				M1L2000				2.5 \$ 7.66
Soho Listel				ML4000				2.6 \$ 6.12
Soho Pencil				ML4010				3.3 \$ 7.66
Rope Liner					M1L2010			4.2 \$ 11.08
Dome Liner					M1L2050			4.4 \$ 11.08
Dot Liner					M1L2070			4.2 \$ 11.08
Classic Liner					M1L0010			4.9 \$ 11.08
Rope Ogee						M1L2020		7.8 \$ 27.40
Dome Ogee						M1L2040		8.1 \$ 27.40
Damask Border						M1L2080		8.1 \$ 27.12
Classic Ogee						M1L0040		12 \$ 27.40
Laurel Border							M1L2030	12.6 \$ 37.92

QUANTITIES

Pieces per Carton	16	12	12	12	12	12	12	
-------------------	----	----	----	----	----	----	----	--

Cast Metal Decoratives are available in four colors. To order, indicate the color number and the sku.

*Dark Oil Rubbed Bronze = 70 *Brushed Nickel = 24 *Antique Bronze = 21 *Wrought Iron = 68

Wall Tile			Lbs/Ctn	Price
Square 1" x 1"	Brickjoint 1" x 2"	Linear Brick 1/2" x 4"		

PRODUCTS, SIZES, CODES & PRICING

NAMES (colors)				
Starlite Wrought Iron	68 MOSA100-1		5.8	\$ 103.36
Starlite Antique Bronze	21 MOSA100-2		5.8	\$ 103.36
Starlite Brushed Nickel	24 MOSA100-3		5.8	\$ 103.36
Twill Dark Oil Rubbed Bronze		70 MOSA200-4	5.8	\$ 86.00
Twill Brushed Nickel		24 MOSA200-5	5.8	\$ 86.00
Twill Antique Bronze		21 MOSA200-6	5.8	\$ 86.00
Vista Dark Oil Rubbed Bronze			70 MOSA300-7	5.8 \$ 93.42
Vista Brushed Nickel			24 MOSA300-8	5.8 \$ 93.42
Vista Antique Bronze			21 MOSA300-9	5.8 \$ 93.42

Quantities			
Pieces per Carton	2 / .96sf per sheet	2 / .80 sf per sheet	2 / .87 sf per sheet

SKU	Size	PC / CT	SQ/CT	LB / CT	Price
-----	------	---------	-------	---------	-------

PRODUCTS, SIZES, CODES & PRICING

NAMES (colors)

TUMBLED MARBLE

Classic Wheat	TM101	2x2 Mesh	11	11	50	\$	28.64
Classic Wheat	TM102	4x4	50	5.5	30	\$	17.54
Classic Wheat	TM103	3x6	48	6	24	\$	21.58
Classic Wheat	TM104	6x6	24	6	32	\$	18.24
Classic Wheat	TM105	12x12	10	10	56	\$	21.58
Casa Emperador	TM201	2x2 Mesh	11	11	54	\$	32.66
Casa Emperador	TM202	4x4	50	5.5	30	\$	20.00
Casa Emperador	TM203	3x6	48	6	31	\$	24.58
Casa Emperador	TM204	6x6	24	6	32	\$	20.66
Casa Emperador	TM205	12x12	10	10	57	\$	24.58

- All Tumbled Marble is pre-sealed with Q-Seal

Tumbled Marble is available in Travertine color only.
To order, indicate the color number and the sku. *Travertine = 01

Wall Tile							Lbs/Ctn	Price
2" x 2"	4" x 4"	1" x 12"	2x12	3x12	4x12	16x24		

PRODUCTS, SIZES, CODES & PRICING

NAMES (colors)								
Alahambra Dot	M1D024011						2	\$ 8.88
Hermitage Dot	M1D029011						2	\$ 8.88
Plaza Dot	M1D019011						2	\$ 8.92
Alahambra Deco		M1D023011					6	\$ 16.54
Hermitage Deco		M1D028011					6	\$ 16.54
Plaza Deco		M1D018011					5	\$ 11.34
Hermitage Liner			M1L027011				4	\$ 13.58
Plaza Liner			M1L017011				5	\$ 11.30
Alahambra Liner				M1L022011			8	\$ 26.20
Plaza Liner				M1L016011			10	\$ 27.40
Alhambra Liner					M1L021011		14	\$ 37.92
Hermitage Liner					M1L026011		13	\$ 37.92
Plaza Liner					M1L015011		14	\$ 32.82
Hermitage Liner						M1L025011	17	\$ 47.82
Alahambra Ogee						M1L020011	22	\$ 47.82
Hermitage Mural							M1M030011	10 \$ 479.58

Quantities								
Pieces per Carton	16	12	12	12	12	12	1	

Minted Metal is available in Oil Rub Bronze and Oil Rub Nickel. To order, indicate the color number and the sku. *Bronze = 065 *Nickel = 066

Wall Tile							Lbs/Ctn	Price
2" x 2"	4" x 4"	1" x 12"	3x12	4x12	3" x 6"	16" x 24"		

PRODUCTS, SIZES, CODES & PRICING

NAMES (colors)									
Doric Dot	S1D178							3	\$ 6.68
Ibiza Dot	S1D171							3	\$ 6.68
Mosaic Dot	S1D165							3	\$ 6.68
Doric Deco		S1D176						11	\$ 10.48
Ibiza Deco		S1D169						9	\$ 10.48
Mosaic Deco		S1D163						9	\$ 10.48
Doric Liner			S1L175					8	\$ 10.18
Ibiza Liner			S1L168					9	\$ 10.24
Mosaic Liner			S1L162					7	\$ 10.20
Doric Liner				S1L174				23	\$ 18.40
Ibiza Liner				S1L167				21	\$ 18.40
Mosaic Liner				S1L161				22	\$ 18.40
Ibiza Liner					S1L166			26	\$ 23.60
Mosaic Liner					S1L160			28	\$ 23.60
Doric Brick						S1L177		11	\$ 12.94
Ibiza Brick						S1L170		11	\$ 12.94
Mosaic Brick						S1L164		10	\$ 12.94
Ibiza Mural							S1M172	19	\$ 342.34

Quantities									
Pieces per Carton	16	12	12	12	12	12	1		

Stone Shadow is available in Noche and Travertine. To order, indicate the color number and the sku. *Noche = 02 *Travertine = 01

SKU	Size	PC / CT	LB / CT	Price
-----	------	---------	---------	-------

PRODUCTS, SIZES, CODES & PRICING

NAMES (colors)

CAST STONE SWITCH PLATES

Toggle	SW102	Single	12	2	\$	9.40
Toggle	SW104	Double	6	1	\$	15.80
Toggle	SW106	Triple	6	2	\$	19.82
GFCI	SW103	Single	12	2	\$	9.40
GFCI	SW105	Double	6	1	\$	15.80
GFCI	SW107	Triple	6	2	\$	19.82
Duplex	SW101	Single	12	2	\$	9.40
Toggle/Duplex	SW108	Combo	6	1	\$	15.80
Toggle/GFCI	SW109	Combo	6	1	\$	15.80
Quad Toggle	SW120	8.75x5	6	3	\$	25.20

CAST STONE BATH ACCESSORIES

Portico Corner Shelf	SBA101	8"	4	13	\$	46.24
Portico Corner Shelf Large	SBA102	10"	4	21	\$	59.82
Portico Soap Dish	SBA103		4	7	\$	30.56
Portico Post Set • Travertine (01) only	SBA104	Set	12	11	\$	48.86
Portico Towel Bar • Travertine (01) only	SBA105	28"	24	7	\$	14.62
Portico Paper Holder Set • Travertine (01) only	SBA106	Set	12	11	\$	52.38

Cast Stone Switch Plates and Bath Accessories are available in four colors.

To order, indicate the color number and the sku. *Travertine = 01 *Noce = 02 *Sand = 03 *Sahara = 07

CAST METAL SWITCH PLATES

Toggle 5X3	SW402	Single	5	1.5	\$	14.14
Toggle 5X5	SW404	Double	5	2.3	\$	22.02
Toggle 5X7	SW406	Triple	2	1.2	\$	31.46
GFCI 5X3	SW403	Single	5	1.5	\$	14.14
GFCI 5X5	SW405	Double	5	1.5	\$	22.02
GFCI 5X7	SW407	Triple	2	0.8	\$	31.46
Duplex 5X3	SW401	Single	5	1.5	\$	14.14

Cast Metal Switch Plates are available in four colors.

To order, indicate the color number and the sku. *Antique Bronze = 21 *Brushed Nickel = 24 *Wrought Iron = 68 *Oil Rubbed Bronze = 70

Field Tile



12" x 12"

PRODUCTS, SIZES, CODES & PRICING

NAMES (colors)	
Daytona (brown)	UE2Q
Destin (white)	UE2R
Pensacola (almond)	UE2S
PRICING	
	sq. ft.
	\$2.32

WEIGHTS, QUANTITIES & DIMENSIONS

WEIGHTS	
Carton (lbs.)	51
Pallet (lbs.)	1734
QUANTITIES	
Tile per Carton	15
Cartons per Pallet	34
DIMENSIONS	
One Carton (sq. ft.)	14.53
One Pallet (sq. ft.)	494.02

SKU	SIZE	PKG	LBS	PRICE
-----	------	-----	-----	-------

PRODUCTS, SIZES, CODES & PRICING

NAMES (colors)

Agglomerate

Santa Isabel	AG-14-4	4x4	6 s.f./ctn	22	\$ 10.22
Santa Anna	AG-15-4	4x4	6 s.f./ctn	22	\$ 10.22
San Miguel	AG-16-4	4x4	6 s.f./ctn	22	\$ 10.22
San Paolo	AG-17-4	4x4	6 s.f./ctn	22	\$ 10.22
Santa Isabel	AGB1-14	12x4	21 pcs/ctn	30	\$ 17.90
Santa Anna	AGB1-15	12x4	21 pcs/ctn	30	\$ 17.90
Santa Isabel	AGB2-14	12x2	18 pcs/ctn	32	\$ 15.34
Santa Anna	AGB2-15	12x2	18 pcs/ctn	32	\$ 15.34
Santa Isabel	AGB3-14	8x2	30 pcs/ctn	30	\$ 15.34
Santa Anna	AGB3-15	8x2	30 pcs/ctn	30	\$ 15.34
Santa Isabel	AGB4-14	8X1	56 pcs/ctn	25	\$ 12.78
Santa Anna	AGB4-15	8X1	56 pcs/ctn	25	\$ 12.78
Santa Isabel	AGB5-14	8X3 3/4	10 pcs/ctn	22	\$ 23.02
Santa Anna	AGB5-15	8X3 3/4	10 pcs/ctn	22	\$ 23.02
Santa Isabel	AGB6-14	8x4	8pcs/ctn	22	\$ 22.98
Santa Anna	AGB6-15	8x4	8pcs/ctn	22	\$ 22.98
Santa Isabel	AGB7-14	13x4	12pcs/ctn	21	\$ 17.86
Santa Anna	AGB7-15	13x4	12pcs/ctn	21	\$ 17.86
Santa Isabel	AGB8-14	13x2 1/2	18pcs/ctn	18	\$ 15.30
Santa Anna	AGB8-15	13x2 1/2	18pcs/ctn	18	\$ 15.30
Santa Isabel	AGB9-14	7-7/8"x1-3/4"	20 pcs/ctn	10	\$ 13.78
Santa Anna	AGB9-15	7-7/8"x1-3/4"	20 pcs/ctn	10	\$ 13.78
Santa Isabel	AGB10-14	7-7/8"x1-1/8"	24 pcs/ctn	12	\$ 12.78
Santa Anna	AGB10-15	7-7/8"x1-1/8"	24 pcs/ctn	12	\$ 12.78
Santa Isabel	AGD1-14	4X4	50 pcs/ctn	25	\$ 10.22
Santa Anna	AGD1-15	4x4	50 pcs/ctn	25	\$ 10.22
Santa Isabel	AGD2-14	4x4	50 pcs/ctn	25	\$ 10.22
Santa Anna	AGD2-15	4x4	50 pcs/ctn	25	\$ 10.22
Santa Isabel	AGD3-14	4x4	50 pcs/ctn	25	\$ 10.22
Santa Anna	AGD3-15	4x4	50 pcs/ctn	25	\$ 10.22
Santa Isabel	AGD4-14	4x4	44 pcs/ctn	25	\$ 10.22
Santa Anna	AGD4-15	4x4	44 pcs/ctn	25	\$ 10.22
Santa Isabel	AGM2-14	2x2	8 sf/ctn	32	\$ 15.24
Santa Anna	AGM2-15	2x2	8 sf/ctn	32	\$ 15.24
San Miguel	AGM2-16	2x2	8 sf/ctn	32	\$ 15.24

SKU	SIZE	PKG	LBS	PRICE
-----	------	-----	-----	-------

PRODUCTS, SIZES, CODES & PRICING

NAMES (colors)				
San Paolo	AGM2-17	2x2	8 sf/ctn	32 \$ 15.24
Santa Isabel	AGM4-14	Harlequin	6 s.f./ctn	25 \$ 17.90
Santa Anna	AGM4-15	Harlequin	6 s.f./ctn	25 \$ 17.90
San Miguel	AGM4-16	Harlequin	6 s.f./ctn	25 \$ 17.90
San Paolo	AGM4-17	Harlequin	6 s.f./ctn	25 \$ 17.90
Santa Isabel	AGP1-14/17	12x12	8 sf/ctn	18 \$ 25.58
Santa Isabel	AGP2-14	12x12	8 sf/ctn	15 \$ 23.02
Santa Isabel	AGP3-14	12x12	8 sf/ctn	23 \$ 23.02
Santa Isabel	AGP4-14	12x12	8 sf/ctn	18 \$ 23.02
Santa Isabel	AGZ1-14	8x6	10 pcs/ctn	40 \$ 43.26
Santa Isabel	AGZ2-14	8x6	10 pcs/ctn	25 \$ 32.26
Santa Isabel	AGZ3-14	8x6	10 pcs/ctn	25 \$ 32.26

Duratile is all non-stock / special order. Please allow 3 - 5 days for delivery.

SKU	SIZE	PKG	LBS	PRICE
-----	------	-----	-----	-------

PRODUCTS, SIZES, CODES & PRICING

NAMES (colors)

Montego Bay

Falmouth	GLMTL11	11-7/8 x 12-7/8	10 pc/box	20	\$ 34.58
Runaway Bay	GLMRTL12	11-7/8 x 12-7/8	10 pc/box	20	\$ 34.58
Port Royal	GLMRTL13	11-7/8 x 12-7/8	10 pc/box	20	\$ 34.58
Port Antonio	GLMRTL14	11-7/8 x 12-7/8	10 pc/box	20	\$ 34.58
Lucea	GLMRTL15	11-7/8 x 12-7/8	10 pc/box	20	\$ 34.58
Negril	GLMRTL16	11-7/8 x 12-7/8	10 pc/box	20	\$ 34.58

Avons - Brick

Tyne	GLMX11	1-5/8" x 3/4"	10 pc/box	33	\$ 28.76
Tene	GLMX12	1-5/8" x 3/4"	10 pc/box	33	\$ 28.76
Till	GLMX13	1-5/8" x 3/4"	10 pc/box	33	\$ 28.76
Findhorn	GLMX14	1-5/8" x 3/4"	10 pc/box	33	\$ 28.76
Dane	GLMX15	1-5/8" x 3/4"	10 pc/box	33	\$ 28.76
Wey	GLMX16	1-5/8" x 3/4"	10 pc/box	33	\$ 29.94
Wansbeck	GLMMX11	1-5/8" x 3/4"	10 pc/box	33	\$ 29.94
Derwent	GLMMX12	1-5/8" x 3/4"	10 pc/box	33	\$ 29.94
Tiber	GLMMX13	1-5/8" x 3/4"	10 pc/box	33	\$ 29.96

Avons - Oval

Tyne	GLMH11	11-1/2" x 11"	10 pc/box	30	\$ 31.18
Till	GLMH13	11-1/2" x 11"	10 pc/box	30	\$ 31.18
Findhorn	GLMH14	11-1/2" x 11"	10 pc/box	30	\$ 31.18
Dane	GLMH15	11-1/2" x 11"	10 pc/box	30	\$ 31.18
Wey	GLMH16	11-1/2" x 11"	10 pc/box	30	\$ 31.18
Wansbeck	GLMMH11	11-1/2" x 11"	10 pc/box	30	\$ 32.46
Derwent	GLMMH12	11-1/2" x 11"	10 pc/box	30	\$ 32.46
Tiber	GLMMH13	11-1/2" x 11"	10 pc/box	30	\$ 32.46
Trent	GLMMH14	11-1/2" x 11"	10 pc/box	30	\$ 32.46

Avons - Round

Tyne	GLMR11	12" X 12"	11 pc/box	30	\$ 33.78
Till	GLMR13	12" X 12"	11 pc/box	30	\$ 33.78
Findhorn	GLMR14	12" X 12"	11 pc/box	30	\$ 33.78
Dane	GLMR15	12" X 12"	11 pc/box	30	\$ 33.78
Wey	GLMR16	12" X 12"	11 pc/box	30	\$ 33.78
Wansbeck	GLMMR11	12" X 12"	11 pc/box	30	\$ 35.32
Derwent	GLMMR12	12" X 12"	11 pc/box	30	\$ 35.32
Tiber	GLMMR13	12" X 12"	11 pc/box	30	\$ 35.32
Trent	GLMMR14	12" X 12"	11 pc/box	30	\$ 35.32

	SKU	SIZE	PKG	LBS	PRICE
--	-----	------	-----	-----	-------

PRODUCTS, SIZES, CODES & PRICING

NAMES (colors)

Avons - Water Drop

Tene	GLMV12	12 x 12	10 pc/box	33	\$ 31.20
Till	GLMV13	12 x 12	10 pc/box	33	\$ 31.20
Findhorn	GLMV14	12 x 12	10 pc/box	33	\$ 31.20
Dane	GLMV15	12 x 12	10 pc/box	33	\$ 31.20
Wey	GLMV16	12 x 12	10 pc/box	33	\$ 31.20
Spey	GLMV17	12 x 12	10 pc/box	33	\$ 31.20
Wansbeck	GLMMV11	12 x 12	10 pc/box	33	\$ 32.46
Derwent	GLMMV12	12 x 12	10 pc/box	33	\$ 32.46
Tiber	GLMMV13	12 x 12	10 pc/box	33	\$ 32.46

Avons - Glass Border

Tyne	GB11-37	7-3/4 x 2-1/8	15 pc/box	18	\$ 20.28
Tene	GB12-37	7-3/4 x 2-1/8	15 pc/box	18	\$ 20.28
Till	GB13-37	7-3/4 x 2-1/8	15 pc/box	18	\$ 20.28
Findhorn	GB14-37	7-3/4 x 2-1/8	15 pc/box	18	\$ 20.28
Dane	GB15-37	7-3/4 x 2-1/8	15 pc/box	18	\$ 20.28
Wey	GB16-37	7-3/4 x 2-1/8	15 pc/box	18	\$ 20.28
Tyne	GB11-38	7-3/4 x 3/4	40 pc/box	18	\$ 14.12
Tene	GB12-38	7-3/4 x 3/4	40 pc/box	18	\$ 14.12
Till	GB13-38	7-3/4 x 3/4	40 pc/box	18	\$ 14.12
Findhorn	GB14-38	7-3/4 x 3/4	40 pc/box	18	\$ 14.12
Dane	GB15-38	7-3/4 x 3/4	40 pc/box	18	\$ 14.12
Wey	GB16-38	7-3/4 x 3/4	40 pc/box	18	\$ 14.12

High Gloss

Wisteria	GLM16	1X1	16 Sq. Ft./Box	30	\$ 18.40
Sea Coral	GLM18	1X1	16 Sq. Ft./Box	30	\$ 18.40
Sand	GLM19	1X1	16 Sq. Ft./Box	30	\$ 18.40
Olive Green	GLM28	1X1	16 Sq. Ft./Box	30	\$ 18.40
Caymen Green	GLM29	1X1	16 Sq. Ft./Box	30	\$ 18.40
Norweigan	GLMM14	1X1	16 Sq. Ft./Box	30	\$ 18.40
Indian	GLMM15	1X1	16 Sq. Ft./Box	30	\$ 18.40

Frosted

Spring Green	GLMS21	12 x 12	16 sf/ctn	30	\$ 22.36
Snow White	GLMS22	12 x 12	16 sf/ctn	30	\$ 22.36
Caymen Green	GLMS29	12 x 12	16 sf/ctn	30	\$ 22.36
Windward Blue	GLMS30	12 x 12	16 sf/ctn	30	\$ 22.36
Raven	GLMS31	12 x 12	16 sf/ctn	30	\$ 22.36
Cadet Gray	GLMS33	12 x 12	16 sf/ctn	30	\$ 29.32
Caribbean	GLMMS12	12 x 12	16 sf/ctn	30	\$ 31.88
Pacific	GLMMS13	12 x 12	16 sf/ctn	30	\$ 31.88
Norwegian	GLMMS14	12 x 12	16 sf/ctn	30	\$ 31.88

Duratile is all non-stock / special order. Please allow 3 - 5 days for delivery.

SKU	SIZE	PKG	LBS	PRICE
-----	------	-----	-----	-------

PRODUCTS, SIZES, CODES & PRICING

NAMES (colors)

Granite

Lincoln Brown	G11	12 x 12	10 Sq. Ft./Box	55	\$ 13.28
Washington Gray	G12	12 x 12	10 Sq. Ft./Box	55	\$ 22.62
Roosevelt white	G14	12 x12	10 Sq. Ft./Box	55	\$ 11.98
Roosevelt white	G14F-4	4 x 4	5 Sq. Ft./Box	23	\$ 13.80
Roosevelt white	G14F-8/4	8 x 4	5 Sq. Ft./Box	23	\$ 13.80
Adams Black	G15	12 x 12	10 Sq. Ft./Box	55	\$ 19.20
Adams Black	G15-18	18 x 18	11.25 Sq.Ft./Box	80	\$ 22.52
Coolidge Green	G16	12 x 12	10 Sq. Ft./Box	55	\$ 22.62
McKinley Red	G17	12 x 12	10 Sq. Ft./Box	55	\$ 15.94
Wilson Yellow	G18	12 x 12	10 Sq. Ft./Box	55	\$ 18.62
Grant Green	G23	12 x12	10 Sq. Ft./Box	55	\$ 23.94
Johnson White	G29	12 x12	10 Sq. Ft./Box	55	\$ 17.98
Pierce Mauve	G31	12 x12	10 Sq. Ft./Box	55	\$ 13.28
Cleveland Gold	G32	12 x12	10 Sq. Ft./Box	55	\$ 13.28
Kennedy Green	G33	12 x12	10 Sq. Ft./Box	55	\$ 25.96
Eisenhower Green	G37	12 x12	10 Sq. Ft./Box	55	\$ 26.58
Van Buren Violet	G39	12 x12	10 Sq. Ft./Box	55	\$ 29.24

Pebble Stone

St. Vincent	RR11-PAT 5	12" x 12"	10 pc/box	50	\$ 17.82
St. Lucia	RR12-PAT 5	12" x 12"	10 pc/box	50	\$ 17.82
St. Kitts	RR13-PAT 5	12" x 12"	10 pc/box	50	\$ 17.82
St. Martin	RR14-PAT 5	12" x 12"	10 pc/box	50	\$ 17.82
St. Vincent	RRB21-11	4" x 12"	10 pc/box	17	\$ 30.06
St. Lucia	RRB21-12	4" x 12"	10 pc/box	17	\$ 30.06
St. Kitts	RRB21-13	4" x 12"	10 pc/box	17	\$ 30.06
St. Martin	RRB21-14	4" x 12"	10 pc/box	17	\$ 30.06

Duratile is all non-stock / special order. Please allow 3 - 5 days for delivery.

SKU	SIZE	PKG	LBS	PRICE
-----	------	-----	-----	-------

PRODUCTS, SIZES, CODES & PRICING

NAMES (colors)

Hand Made Ceramic Tile

Metal	CM01-4	4 x 4	45 pc/box	47	\$ 6.04
Wood	CM02-4	4 x 4	45 pc/box	47	\$ 6.04
Water	CM03-4	4 x 4	45 pc/box	47	\$ 6.04
fire	CM04-4	4 x 4	45 pc/box	47	\$ 6.04
Earth	CM05-4	4 x 4	45 pc/box	47	\$ 6.04
Sun	CM06-4	4 x 4	45 pc/box	47	\$ 6.04
Moon	CM07-4	4 x 4	45 pc/box	47	\$ 6.04
Star	CM08-4	4 x 4	45 pc/box	47	\$ 6.04
Heaven	CM09-4	4 x 4	45 pc/box	47	\$ 6.04
Metal	CF01-4	4 x 4	45 pc/box	47	\$ 6.04
Wood	CF02-4	4 x 4	45 pc/box	47	\$ 6.04
Water	CF03-4	4 x 4	45 pc/box	47	\$ 6.04
fire	CF04-4	4 x 4	45 pc/box	47	\$ 6.04
Earth	CF05-4	4 x 4	45 pc/box	47	\$ 6.04
Sun	CF06-4	4 x 4	45 pc/box	47	\$ 6.04
Moon	CF07-4	4 x 4	45 pc/box	47	\$ 6.04
star	CF08-4	4 x 4	45 pc/box	47	\$ 6.04
Heaven	CF09-4	4 x 4	45 pc/box	47	\$ 6.04

Duratile is all non-stock / special order. Please allow 3 - 5 days for delivery.

SKU	SIZE	PKG	LBS	PRICE
-----	------	-----	-----	-------

PRODUCTS, SIZES, CODES & PRICING

NAMES (colors)

Marble

Black Magic	A14-4	4 x 4	10 Sq. Ft./Box	55	\$ 21.78
Black Magic	M14	12 x 12	10 Sq. Ft./Box	55	\$ 17.04
Black Magic	M14-Pat	Various	5 Sq. Ft./Box	23	\$ 25.04
Black Magic	MM14-T	5/8 x 5/8	10 Sq. Ft./Box	55	\$ 33.04
Thunder Night	A15	12 x 12	10 Sq. Ft./Box	55	\$ 22.40
Thunder Night	A15-4	4 x 4	10 Sq. Ft./Box	55	\$ 22.40
Thunder Night	M15	12 x 12	10 Sq. Ft./Box	55	\$ 13.70
Thunder Night	MM15-T	5/8 x 5/8	5 Sq. Ft./Box	23	\$ 33.04
Beige Classic	MM16-P	5/8 x 5/8	5 Sq. Ft./Box	23	\$ 33.04
Beige Classic	MM16-T	5/8 x 5/8	5 Sq. Ft./Box	23	\$ 33.04
Ming Jade	M18	12 x 12	10 Sq. Ft./Box	55	\$ 24.94
White Pearl	M20	12 x 12	10 Sq. Ft./Box	55	\$ 27.94
White Pearl	M20H	12 x 12	10 Sq. Ft./Box	55	\$ 29.34
White Pearl	M20-4-PI	4 x 4	10 Sq. Ft./Box	55	\$ 27.34
White Pearl	M20-GLMMR11	12-1/4"x10-3/4"	10 pc/box	35	\$ 53.76
White Pearl	M20-PAT 3	13 x 11-3/16	5 Sq. Ft./Box	30	\$ 44.12
White Pearl	M20-PAT 4	11 x 11	5 Sq. Ft./Box	24	\$ 25.68
White Pearl	MB22-20	2-3/4 x 12	10 pc/box	20	\$ 41.32
White Pearl	MB24-20	4 x 12	5 pc/box	12	\$ 39.80
White Pearl	MB25-20	3/4 x12	30 pc/box	25	\$ 14.34
White Pearl	MM12-20-H	11-1/2 x 11-1/2	5 Sq. Ft./Box	26	\$ 29.30
White Pearl	MM20-T	5/8 x 5/8	5 Sq. Ft./Box	23	\$ 38.00
White Pearl	MM3-20-H	1-1/2 x 3/4	5 Sq. Ft./Box	28	\$ 41.58
White Pearl	MM4-20-H	12-1/4 x 15-1/8	5 Sq. Ft./Box	38	\$ 43.52
White Pearl	MM6-20-Pi	3 x 6	10 sq.ft./ctn	50	\$ 31.54
Seascape	A21	12 x 12	10 Sq. Ft./Box	55	\$ 19.62
Seascape	A21-4	4 x 4	10 Sq. Ft./Box	55	\$ 19.62
Seascape	M21	12 x 12	10 Sq. Ft./Box	55	\$ 17.84
Seascape	M21-Pat	Various	5 Sq. Ft./Box	23	\$ 25.04
Seascape	MM21-P	5/8 x 5/8	5 Sq. Ft./Box	23	\$ 33.04
Seascape	MM21-T	5/8 x 5/8	5 Sq. Ft./Box	23	\$ 33.04
Gobi	A22	12 x 12	10 Sq. Ft./Box	55	\$ 19.62
Gobi	A22-4	4 x 4	10 Sq. Ft./Box	55	\$ 19.62
Gobi	M22	12 x 12	10 Sq. Ft./Box	55	\$ 17.84
Gobi	MM22-T	5/8 x 5/8	5 Sq. Ft./Box	23	\$ 33.04

SKU	SIZE	PKG	LBS	PRICE
-----	------	-----	-----	-------

PRODUCTS, SIZES, CODES & PRICING

NAMES (colors)				
Majestic Grey	M27	12 x 12	10 Sq. Ft./Box	55 \$ 20.00
Lotus Green	A29	12 x 12	10 Sq. Ft./Box	55 \$ 22.30
Lotus Green	A29-4	4 x 4	10 Sq. Ft./Box	55 \$ 22.30
Napoleon	M29	12 x 12	10 Sq. Ft./Box	55 \$ 15.58
Sea Foam	M30	12 x 12	10 Sq. Ft./Box	55 \$ 21.64
Sea Foam	M30-4-T	4 x 4	10 sq.ft./ctn	55 \$ 30.52
Sea Foam	MB18-30-T	12 x 1	24 pcs/ctn	41 \$ 23.24
Sea Foam	MB22-30-T	12 x 2-3/4	10 pcs/ctn	30 \$ 39.14
Sea Foam	MB24-30-T	12 x 4	5 pcs/ctn	40 \$ 44.62
Sea Foam	MM2-30-T	2 x 2	5 sq.ft./ctn	23 \$ 34.58
Sea Foam	MM-30-T	5/8 x 5/8	5 sq.ft./ctn	23 \$ 36.26
Sea Foam	MM3-30-T	3/4 x 1-1/2	5 sq.ft./ctn	23 \$ 36.86
Sea Foam	MM4-30-T	Harlequin	5 sq.ft./ctn	23 \$ 36.86
Sea Foam	MM6-30-T	3 x 6	5 sq.ft./ctn	23 \$ 35.06
Sea Foam	MM6-30-Pi	3 x 6	10 sq.ft./ctn	50 \$ 31.56
Monet	M31	12 x 12	10 Sq. Ft./Box	55 \$ 16.46
Rosewood	MM32-T	5/8 x 5/8	5 Sq. Ft./Box	23 \$ 34.64
Petrifield Forest	A34	12 x 12	10 Sq. Ft./Box	55 \$ 22.40
Petrifield Forest	A34-4	4 x 4	10 Sq. Ft./Box	55 \$ 22.40
Marseille	M37	12 x 12	10 Sq. Ft./Box	55 \$ 21.20
Empress Gold	M40	12 x 12	10 Sq. Ft./Box	55 \$ 23.62
Empress Gold	M40-4-T	4 x 4	10 sq.ft./ctn	55 \$ 31.70
Empress Gold	M40-H	12 X 12	10 Sq. Ft./Box	55 \$ 25.00
Empress Gold	MB18-40-T	12 x 1	24 pcs/ctn	41 \$ 24.30
Empress Gold	MB22-40-T	12 x 2-3/4	10 pcs/ctn	30 \$ 40.14
Empress Gold	MB24-40-T	12 x 4	5 pcs/ctn	40 \$ 47.94
Empress Gold	MM2-40-T	2 x 2	5 sq.ft./ctn	23 \$ 39.60
Empress Gold	MM3-40-T	3/4 x 1-1/2	5 sq.ft./ctn	23 \$ 41.42
Empress Gold	MM-40-T	5/8 x 5/8	5 sq.ft./ctn	23 \$ 36.26
Empress Gold	MM4-40-T	Harlequin	5 sq.ft./ctn	23 \$ 41.42
Empress Gold	MM6-40-T	3 x 6	5 sq.ft./ctn	23 \$ 39.60
Empress Gold	MM6-40-Pi	3 x 6	10 sq.ft./ctn	50 \$ 33.00
Hugo	M46	12 x 12	10 Sq. Ft./Box	55 \$ 18.26
Plato	M47	12 x 12	10 Sq. Ft./Box	55 \$ 18.26
Renaissance	M93	12 x 12	10 sq.ft./box	60 \$ 23.20
Renaissance	M93-GLMMR13	12-1/4"x10-3/4"	10 pc/box	35 \$ 48.96
Renaissance	M93-PAT	Various	15.5 sq ft/Box	90 \$ 22.36
Renaissance	M93-4-Pi	4 x 4	9 Sq.Ft./Box	45 \$ 39.84
Renaissance	MM6-93-Pi	3 x 6	8 pcs/ctn	5 \$ 39.84

	SKU	SIZE	PKG	LBS	PRICE
PRODUCTS, SIZES, CODES & PRICING					
NAMES (colors)					
Renaissance	MM4-93-Pi	Harlequin	8 pcs/ctn	5	\$ 59.32
Renaissance	MM8-93-T	Broken Tumbled Edge	5 Sq. Ft/Box	22	\$ 32.12
Renaissance	MM11-93-T	Split and Tumbled	5 Sq. Ft/Box	26	\$ 37.80
Renaissance	MM93-T	5/8 x 5/8	5 Sq. Ft/Box	20	\$ 36.96
Renaissance	MM2-93-T	2 x 2	5 Sq. Ft/Box	26	\$ 30.74
Renaissance	MP-11-93	Basket Weave	5 Sq. Ft/Box	20	\$ 43.62
Renaissance	M93-PAT 5	Random Pattern	5 Sq. Ft/Box	22	\$ 23.06
Renaissance	MB17-93	2 x 12	8 pcs/ctn	18	\$ 36.90
Renaissance	MB21-93	5/8 x 12	20 pcs/ctn	10	\$ 17.34
Renaissance	MB22-93	2-3/4 x 12	8 pcs/ctn	22	\$ 44.34
Miro	M95-4-Pi	4 x 4	9 Sq.Ft./Box	45	\$ 41.06
Miro	MM6-95-Pi	3 x 6	8 pcs/ctn	5	\$ 45.04
Miro	MM4-95-Pi	Harlequin	8 pcs/ctn	5	\$ 65.00
Miro	MM8-95-T	12 x 12	5 Sq. Ft./Box	22	\$ 34.60
miro	MM11-95-T	12 x 12	5 Sq. Ft./Box	24	\$ 42.12
Miro	MM95-T	5/8 x 5/8	5 Sq. Ft./Box	20	\$ 39.62
Miro	MM2-95-T	2 x 2	5 Sq. Ft/Box	28	\$ 33.22
Miro	MP-11-95	12 x 12	5 Sq.Ft./Box	19	\$ 45.02
Miro	M95-PAT 5	12 x 12	5 Sq. Ft./Box	20	\$ 25.54
Miro	MB17-95	2 x 12	24 pcs/ctn	17	\$ 39.26
Miro	MB21-95	5/8 x 12	20 pcs/ctn	10	\$ 19.72
Miro	MB22-95	2-3/4 x 12	8 pcs/ctn	20	\$ 46.70
Dali	M96-4-Pi	4 x 4	9 Sq.Ft./Box	45	\$ 50.24
Dali	MM6-96-Pi	3 x 6	8 pcs/ctn	5	\$ 50.24
Dali	MM4-96-Pi	Harlequin	8 pcs/ctn	5	\$ 70.68
Dali	MM8-96-T	12 x 12	5 Sq. Ft./Box	22	\$ 38.02
Dali	MM11-96-T	12 x 12	5 Sq. Ft./Box	28	\$ 24.96
Dali	MM96-T	5/8 x 5/8	5 Sq. Ft./Box	22	\$ 24.96
Dali	MM2-96-T	2 x 2	5 Sq. Ft./Box	25	\$ 36.66
Dali	MP-11-96	12 x 12	5 Sq. Ft./Box	20	\$ 45.98
Dali	M96-PAT 5	12 x 12	5 Sq. Ft./Box	20	\$ 28.96
Dali	MB17-96	2 x 12	8 pcs/ctn	18	\$ 40.52
Dali	MB21-96	5/8 x 12	20 pcs/ctn	11	\$ 20.98
Dali	MB22-96	2-3/4 x 12	8 pcs/ctn	20	\$ 47.96
Mixed	MB31	4 x 12	15 pcs./Box	25	\$ 33.38
Mixed	MB32	3 x 12	20 pcs./Box	25	\$ 21.08
Mixed	MB33	2-2/5 x 12	25 pcs./Box	25	\$ 21.08
Mixed	MB34	2-2/5 x 12	25 pcs./Box	20	\$ 19.72
Mixed	MB35	4 x 12	15 pcs./Box	25	\$ 33.38
Mixed	MB939596	12 x 12	5 pcs./Box	20	\$ 39.32
Alexandra	M94-PAT	Various	15.5 sq ft/Box	90	\$ 23.30

Duratile is all non-stock / special order. Please allow 3 - 5 days for delivery.

SKU	SIZE	PKG	LBS	PRICE
-----	------	-----	-----	-------

PRODUCTS, SIZES, CODES & PRICING

NAMES (colors)

Metal - Traditional

Grape Leaf	Z-D7 4/4-BSP	4 x 4	1 Piece/Pack	0.5	\$ 25.04
Grape Leaf	Z-D7 4/4-AB	4 x 4	1 Piece/Pack	0.5	\$ 25.04
Grape Leaf	Z-D7 4/4-AC	4 x 4	1 Piece/Pack	0.5	\$ 25.04
Grapes	Z-D8 4/4-BSP	4 x 4	1 Piece/Pack	0.5	\$ 25.04
Grapes	Z-D8 4/4-AB	4 x 4	1 Piece/Pack	0.5	\$ 25.04
Grapes	Z-D8 4/4-AC	4 x 4	1 Piece/Pack	1	\$ 25.04
Pentas	Z-D9 4/4-BSP	4 x 4	1 Piece/Pack	1	\$ 25.04
Pentas	Z-D9 4/4-AB	4 x 4	1 Piece/Pack	1	\$ 25.04
Pentas	Z-D9 4/4-AC	4 x 4	1 Piece/Pack	1	\$ 25.04
Corithian	Z-D10 4/4-BSP	4 x 4	1 Piece/Pack	1	\$ 25.04
Corithian	Z-D10 4/4-AB	4 x 4	1 Piece/Pack	1	\$ 25.04
Corithian	Z-D10 4/4-AC	4 x 4	1 Piece/Pack	1	\$ 25.04

Metal - Western

Cactus	CI-C-AC 4/4	4 x 4	1 Piece/Pack	1	\$ 25.04
Cactus	CI-C-AB 4/4	4 x 4	1 Piece/Pack	1	\$ 25.04
Cactus	CI-C-CI 4/4	4 x 4	1 Piece/Pack	1	\$ 25.04
Cowboy Boots	CI-CB-AC 4/4	4 x 4	1 Piece/Pack	1	\$ 25.04
Cowboy Boots	CI-CB-AB 4/4	4 x 4	1 Piece/Pack	1	\$ 25.04
Cowboy Boots	CI-CB-CI 4/4	4 x 4	1 Piece/Pack	1	\$ 25.04
Saddle	CI-S-AC 4/4	4 x 4	1 Piece/Pack	1	\$ 25.04
Saddle	CI-S-AB 4/4	4 x 4	1 Piece/Pack	1	\$ 25.04
Saddle	CI-S-CI 4/4	4 x 4	1 Piece/Pack	1	\$ 25.04
Texas Star	CI-TS-AC 4/4	4 x 4	1 Piece/Pack	1	\$ 25.04
Texas Star	CI-TS-AB 4/4	4 x 4	1 Piece/Pack	1	\$ 25.04
Texas Star	CI-TS-CI 4/4	4 x 4	1 Piece/Pack	1	\$ 25.04
Cowboy Hat	CI-CH-AC 4/4	4 x 4	1 Piece/Pack	1	\$ 25.04
Cowboy Hat	CI-CH-AB 4/4	4 x 4	1 Piece/Pack	1	\$ 25.04
Cowboy Hat	CI-CH-CI 4/4	4 x 4	1 Piece/Pack	1	\$ 25.04
Dream Catcher	CI-DC-AC 4/4	4 x 4	1 Piece/Pack	1	\$ 25.04
Dream Catcher	CI-DC-AB 4/4	4 x 4	1 Piece/Pack	1	\$ 25.04
Dream Catcher	CI-DC-CI 4/4	4 x 4	1 Piece/Pack	1	\$ 25.04

Duratile is all non-stock / special order. Please allow 3 - 5 days for delivery.

SKU	SIZE	PKG	LBS	PRICE
-----	------	-----	-----	-------

PRODUCTS, SIZES, CODES & PRICING

NAMES (colors)

Travertine

San Cristo	T13-4-T	4 x 4	10 Sq. Ft./Box	28	\$ 16.10
San Cristo	T13-4-Pi	4 x 4	10 Sq. Ft./Box	28	\$ 22.42
San Cristo	T13-T	12 x 12	10 Sq. Ft./Box	55	\$ 23.04
San Cristo	T13-S-Ram	15-2/3" X 15-2/3"	8.5 Sq.Ft./Box	36	\$ 21.84
San Cristo	TM-13-T	5/8 x 5/8	5 Sq. Ft./Box	25	\$ 24.62
San Cristo	TM2-13-T	2 x 2	5 Sq. Ft./Box	27	\$ 19.78
San Cristo	TM3-13-T	3/4 x 1 1/2	5 Sq. Ft./Box	24	\$ 24.62
San Cristo	TM4-13-T	Harlequin	5 Sq. Ft./Box	25	\$ 24.62
San Cristo	TM5-13-T	Hexagon	5 Sq. Ft./Box	23	\$ 24.62
San Cristo	TM6-13-T	3 x 6	5 Sq. Ft./Box	25	\$ 21.06
San Cristo	TM6-13-PI	3 X 6	5 Sq. Ft./Box	25	\$ 22.42
San Cristo	TM6-13-Pi 2S	3 x 6	5 Sq. Ft./Box	25	\$ 20.20
San Cristo	TB17-13-T-12/2	12 x 2	8 pieces/Box	20	\$ 21.86
San Cristo	TB18-13-T-12/1	12 x 1	10 pieces/Box	14	\$ 20.44
San Cristo pencil rail	TB21-13-T	5/8 X 12	20 pc / box	10	\$ 13.48
San Cristo chair rail	TB22-13-T	2-3/4 x 12	8 pc / box	18	\$ 22.42
Roman Pillars	TB25-13-T	12 x 4	10 Sq. Ft./Box	14	\$ 17.62
San Cristo Pattern	TP11-13	12 X 12	5 pc / box	27.5	\$ 36.78
Basket Weave	TP12-13	11 x 11	5 pc / box	19	\$ 36.78

Quartzite

Galaxy Verde	Q11	12 x 12	10 Sq. Ft./Box	55	\$ 18.14
Galaxy Verde	Q11-6	6 x 12	No Box	3	\$ 18.14
Galaxy Verde Honed	Q11-H	12 x 12	10 Sq. Ft./Box	55	\$ 19.30
Galaxy Rose	Q12	12 x 12	10 Sq. Ft./Box	55	\$ 18.14
Galaxy Rose Honed	Q12-H	12 x 12	10 Sq. Ft./Box	55	\$ 19.30
Galaxy Blanco	Q13	12 x 12	10 Sq. Ft./Box	55	\$ 18.42

Sandstone

Bayberry	P12-H	12 x 12	10 sf / ctn	55	\$ 17.86
Terra Rosata	P12-H	12 x 12	10 sf / ctn	55	\$ 17.86

Duratile is all non-stock / special order. Please allow 3 - 5 days for delivery.

SKU	SIZE	PKG	LBS	PRICE
-----	------	-----	-----	-------

PRODUCTS, SIZES, CODES & PRICING

NAMES (colors)

Slate

Green	S12	12 x 12	10 Sq. Ft./Box	58	\$ 10.00
Green	S12-16	16 x 16	10.7Sq.Ft./Box	70	\$ 11.56
Green	S12-Pat	Various	15.5Sq.Ft/Box	115	\$ 11.98
Green	S12-4-T	4 x 4	10 Sq. Ft./Box	55	\$ 13.90
Green	SM2-12-T	2 x 2	5 Sq. Ft./Box	23	\$ 38.30
Green	SM3-12-T	3/4 x 1 1/2	5 Sq. Ft./Box	23	\$ 25.30
Green	SM4-12-T	Harlequin	5 Sq. Ft./Box	23	\$ 25.80
Green	SM5-12-T	Hexagon	5 Sq. Ft./Box	23	\$ 26.80
Green	SM6-12-T	3 x 6	5 Sq. Ft./Box	23	\$ 22.94
Black	S13	12 x 12	10 Sq. Ft./Box	55	\$ 9.56
Black	S13-16	16 x 16	10.7 Sq. Ft./Box	55	\$ 11.04
Black	S13-4-T	4 x 4	10 Sq. Ft./Box	55	\$ 14.14
Spanish Moss	S16	12 x 12	10 Sq. Ft./Box	55	\$ 11.58
Spanish Moss	S16-4-T	4 x 4	10 Sq. Ft./Box	55	\$ 14.62
Spanish Moss	SM2-16-T	2 x 2	5 Sq. Ft./Box	23	\$ 23.54
Spanish Moss	SM3-16-T	3/4 x 1 1/2	5 Sq. Ft./Box	23	\$ 25.30
Spanish Moss	SM4-16-T	Harlequin	5 Sq. Ft./Box	23	\$ 25.80
Spanish Moss	SM6-16-T	3 x 6	5 Sq. Ft./Box	23	\$ 22.94
Spanish Moss/Sea Foam	SM9-16-T	12 x 9.5	5pcs./box	23	\$ 21.60
Spanish Moss	SM17-16	11-3/5 x 9-5/6	5 pc/ box	19	\$ 25.18
Desert Sage	S18	12 x 12	10 Sq. Ft./Box	55	\$ 11.80
Desert Sage	S18-16	16 x 16	10.7 Sq. Ft./Box	55	\$ 12.32
Desert Sage	S18-24	24 x 24	4 Sq. Ft. a piece	20	\$ 21.80
Desert Sage	S18-Pat	Various	15.5 Sq.Ft/Box	115	\$ 13.70
Desert Sage	S18-Pat-2	Various	2.7 Sq.Ft./piece	65	\$ 16.02
Desert Sage	S18-Ram	Various	3 Sq.Ft. a piece	13	\$ 14.64
Desert Sage	S18-S-Ram	Various	8.5 Sq.Ft./Box	34	\$ 21.54
Desert Sage	S18-4-T	4 x 4	10 Sq. Ft./Box	55	\$ 13.90

SKU	SIZE	PKG	LBS	PRICE
-----	------	-----	-----	-------

PRODUCTS, SIZES, CODES & PRICING

NAMES (colors)				
Desert Sage	S18-6-T	6 x 6	10 Sq. Ft./Box	55 \$ 13.90
Desert Sage	S18-8-T	8 x 8	10.7 Sq. Ft./Box	55 \$ 15.32
Desert Sage	SM-18-T	5/8 x 5/8	5 Sq. Ft./Box	23 \$ 25.38
Desert Sage	SM2-18-T	2 x 2	5 Sq. Ft./Box	23 \$ 23.54
Desert Sage	SM3-18-T	3/4 x 1 1/2	5 Sq. Ft./Box	23 \$ 25.30
Desert Sage	SM4-18-T	Harlequin	5 Sq. Ft./Box	23 \$ 25.80
Desert Sage	SM5-18-T	Hexagon	5 Sq. Ft./Box	23 \$ 26.80
Desert Sage	SM6-18-T	3 x 6	5 Sq. Ft./Box	23 \$ 22.94
Desert Sage	SM7-18-T	Various	5 Sq. Ft./Box	23 \$ 23.08
White pearl/Desert sage	SM9-18-T	12 x 9.5	5pcs./box	23 \$ 21.60
Desert Sage	SM17-18	11-3/5 x 9-5/6	5 pc/ box	19 \$ 25.18
Desert Sage	SM18-18-H	12 x 11-3/4	5 pc/ box	36 \$ 27.40
Desert Sage	B13-18-T-12/5	5 x 12	10 pieces/Box	20 \$ 18.02
Desert Sage	B14-18-T-12/5	5 x 12	10 pieces/Box	20 \$ 18.02
Desert Sage	B17-18-T-12/2	2 x 12	8 pieces/Box	18 \$ 21.86
Desert Sage	B18-18-T-12/1	1 x 12	10 pieces/Box	18 \$ 19.66
Desert Sage	B20-18-T-12/5	5 x 12	10 pieces/Box	18 \$ 18.02
Desert Sage & Multi-Color	B26-18/19-T	12 x 2	30 pc/box	24 \$ 12.62
Desert Sage & Multi-Color	B27-18/19-T	12 x 3	20 pc/box	29 \$ 13.86
Desert Sage & Multi-Color	B28-18/19-T	13.5 x 4	15 pc/box	20 \$ 17.62
Travertine & Multi-Color	B29-13/19-T	12 x 3	20 pc/box	26 \$ 16.62
Desert Sage & Multi-Color	B30-18/19-T	12 x 12	1 pc	6 \$ 24.42
Multi-color	S19	12 x 12	10 Sq. Ft./Box	55 \$ 7.72
Multi-color	S19-(12 x 24)	12 x 24	10 Sq. Ft./Box	55 \$ 10.98
Multi-color	S19-16	16 x 16	10.7 Sq. Ft./Box	70 \$ 8.16
Multi-color	S19-24	24 x 24	4 Sq. Ft. a piece	35 \$ 12.02
Multi-color	S19-Pat	Various	15.5 Sq.Ft/Box	115 \$ 9.82
Multi-color	S19-Pat-2	Various	10.76 Sq.Ft./box	65 \$ 10.88
Multi-color	S19-Ram	Various	3 Sq.Ft. a piece	16 \$ 12.08
Multi-color	S19-S-Ram	Various	8.5 Sq.Ft./Box	30 \$ 19.86
Multi-color	S19-4-T	4 x 4	10 Sq. Ft./Box	58 \$ 13.90
Multi-color	S19-6-T	6 x 6	10 Sq. Ft./Box	58 \$ 13.90
Multi-color	S19-8-T	8 x 8	10.7 Sq. Ft./Box	58 \$ 14.74
Multi-color	SM-19-T	5/8 x 5/8	5 Sq. Ft./Box	23 \$ 25.38
Multi-color	SM2-19-T	2 x 2	5 Sq. Ft./Box	23 \$ 23.54
Multi-color	SM3-19-T	3/4 x 1 1/2	5 Sq. Ft./Box	23 \$ 25.30

SKU	SIZE	PKG	LBS	PRICE
-----	------	-----	-----	-------

PRODUCTS, SIZES, CODES & PRICING

NAMES (colors)				
Multi-color	SM4-19-T	Harlequin	5 Sq. Ft./Box	23 \$ 25.80
Multi-color	SM5-19-T	Hexagon	5 Sq. Ft./Box	23 \$ 26.80
Multi-color	SM6-19-T	3 x 6	5 Sq. Ft./Box	23 \$ 22.94
Multi-color	SM7-19-T	Various	5 Sq. Ft./Box	23 \$ 23.20
Multi-color	SM9-19-T	12 x 9.5	5pcs./box	23 \$ 21.60
Multi-color	SM17-19	11-3/5 x 9-5/6	5 pc/ box	19 \$ 25.18
Multi-color	SM18-19-H	12 x 11-3/4	5 pc/ box	36 \$ 27.40
Multi-color	B13-19-T-12/5	5 x 12	10 pieces/Box	20 \$ 18.02
Multi-color	B14-19-T-12/5	5 x 12	10 pieces/Box	20 \$ 18.02
Multi-color	B17-19-T-12/2	2 x 12	8 pieces/Box	20 \$ 22.42
Multi-color	B18-19-T-12/1	1 x 12	10 pieces/Box	20 \$ 19.66
Multi-color	B20-19-T-12/5	5 x 12	10 pieces/Box	20 \$ 26.88
New England	SM34-T	12 x 12	5 Sq. Ft./Box	28 \$ 28.40
New England, small harlequin	SM4S-34-T	11 x 9.5	5 pc/ box	20 \$ 28.42
Autumn Sage	S22	12 x 12	10 Sq. Ft./Box	55 \$ 11.62
Autumn Sage	S22-16	16 x 16	10.7 Sq. Ft./Box	70 \$ 12.08
Violet	S23	12 x 12	10 Sq. Ft./Box	55 \$ 10.90
Saint Florient	S29	12 x 12	10 Sq. Ft./Box	55 \$ 10.18
Asian Palm	S30	12 x 12	10 Sq. Ft./Box	55 \$ 10.90
Gold Coast	S31	12 x 12	10 Sq. Ft./Box	55 \$ 7.80
Pattern	B15-14/18	10 x 10	5 pieces/Box	22 \$ 28.94
Pattern	B16-14/19	13 x 9	5 pieces/Box	22 \$ 28.94

Duratile is all non-stock / special order. Please allow 3 - 5 days for delivery.

SKU	SIZE	PKG	LBS	PRICE
-----	------	-----	-----	-------

PRODUCTS, SIZES, CODES & PRICING

NAMES (colors)

Stainless Steel

Silver	SS2-01	2 x 2	10 pieces/Box	25	\$ 47.96
Silver	SS4S-01	14-1/8 x 13	10 pieces/Box	26.5	\$ 59.38
Silver	SS6-01	3 x 6	86 pieces/Box	31	\$ 50.78
Silver	SS8-01	12-5/8 x 11-1/2	10 pieces/Box	26	\$ 54.80
Silver	SS12-01	11-1/8 x 13	10 pieces/Box	26	\$ 60.20
Silver	SS13-01	11-1/4 x 11-3/4	10 pieces/Box	24	\$ 60.20
Silver	SS14-01	12 x 12	10 pieces/Box	24	\$ 60.20
Silver	SS15-01	4/5 x 4/5	10 pieces/Box	26.5	\$ 53.32
Silver	SSB-36M	11-3/4 x 3/5	120 pieces/Box	20.2	\$ 15.02
Silver	SSB-36P	11-3/4 x 3/5	120 pieces/Box	20.2	\$ 15.02

Cosmopolitan

Clear glass with stainless steel	SG-15-02	11-3/4 x 11-7/8	5 pc/box	13	\$ 65.52
Clear glass with stainless steel	SG-16-02	12 x 12	5 pc/box	13	\$ 61.16
Clear glass with stainless steel	SG-13-02	11-3/4 x 11-3/4	5 pc/box	13	\$ 69.16
Clear glass with stainless steel	SG-8-02	11-5/8 x 10-1/2	5 pc/box	13	\$ 65.52

Shell

Guam	J11	12-1/4 x 12-1/4	20 sq ft/box	31	\$ 39.92
Guam	JM3S-11	11-1/2" X 11-5/8	20 pc/box	17	\$ 52.22
Guam	JM26-11	11-7/8" X 11-7/8	20 pc/box	18	\$ 51.60
Guam	JM4S-11	11-7/8" X 11-7/8	20 pc/box	15	\$ 45.66
Fiji	J12	12-1/4 x 12-1/4	20 sq ft/box	31	\$ 39.92
Fiji	JM3S-12	11-1/2" X 11-5/8	20 pc/box	17	\$ 52.22
Fiji	JM26-12	11-7/8" X 11-7/8	20 pc/box	18	\$ 51.60
Fiji	JM4S-12	11-7/8" X 11-7/8	20 pc/box	15	\$ 45.66
Guam/Fiji	JMM4S-11/12	11-7/8" X 11-7/8	20 pc/box	15	\$ 80.88
Samoa	J13	12-3/4" X 12-3/4	20 pc/box	20	\$ 39.92
Guam	JM11R	11-3/4" x 11-3/4'	20 pc/box	33	\$ 101.36

Trini

Spsyside	GLMSH11	12 x 12	10 pc/box	33	\$ 40.84
Gaspree	GLMSH12	12 x 12	10 pc/box	33	\$ 40.84
Maracas	GLMSH13	12 x 12	10 pc/box	33	\$ 40.84
St. James	GLMSH14	12 x 12	10 pc/box	33	\$ 40.84
Monas	GLMSH15	12 x 12	10 pc/box	33	\$ 40.84
Manzanilla	GLMSH16	12 x 12	10 pc/box	33	\$ 40.84
Santa Cruz	GLMSH17	12 x 12	10 pc/box	33	\$ 40.84
Marabella	GLMSH18	12 x 12	10 pc/box	33	\$ 40.84
La Brea	GLMSH19	12 x 12	10 pc/box	33	\$ 40.84

Duratile is all non-stock / special order. Please allow 3 - 5 days for delivery.

SKU	SIZE	PKG	LBS	PRICE
-----	------	-----	-----	-------

PRODUCTS, SIZES, CODES & PRICING

NAMES (colors)







Rococo - Stone & Glass Mix

Black Magic	GLMD 14	11-5/8 x 11-5/8	5 pc/box	13	\$ 34.60
White Pearl	GLMD 20	11-5/8 x 11-5/8	5 pc/box	13	\$ 34.60
Napoleon	GLMD 29	11-5/8 x 11-5/8	5 pc/box	13	\$ 34.60
Ming Green	GLMD 30	11-5/8 x 11-5/8	5 pc/box	13	\$ 34.60
Empress Gold	GLMD 40	11-5/8 x 11-5/8	5 pc/box	13	\$ 34.60
Renaissance	GLMD 93	11-5/8 x 11-5/8	5 pc/box	13	\$ 34.60

Brucke - Stone & Glass Mix

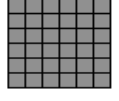
Black Magic	GLMU14	12-3/8" X 11-1/8'	10 pc/box	37	\$ 32.56
White Pearl	GLMU20	12-3/8" X 11-1/8'	10 pc/box	37	\$ 32.56
Jade Green	GLMU25	12-3/8" X 11-1/8'	10 pc/box	37	\$ 32.56
Renaissance	GLMU93	12-3/8" X 11-1/8'	10 pc/box	37	\$ 32.56
Miro	GLMU95	12-3/8" X 11-1/8'	10 pc/box	37	\$ 32.56
Dali	GLMU96	12-3/8" X 11-1/8'	10 pc/box	37	\$ 32.56
Black Magic	GLMU-F-14	12-3/8" X 11-1/8'	10 pc/box	37	\$ 34.60
White Pearl	GLMU-F-20	12-3/8" X 11-1/8'	10 pc/box	37	\$ 34.60
Jade Green	GLMU-F-25	12-3/8" X 11-1/8'	10 pc/box	37	\$ 34.60
Renaissance	GLMU-F-93	12-3/8" X 11-1/8'	10 pc/box	37	\$ 34.60
Miro	GLMU-F-95	12-3/8" X 11-1/8'	10 pc/box	37	\$ 34.60
Dali	GLMU-F-96	12-3/8" X 11-1/8'	10 pc/box	37	\$ 34.60
Black Magic	GLML-14	11-7/8" X 12"	10 pc/box	34	\$ 31.34
White Pearl	GLML-20	11-7/8" X 12"	10 pc/box	34	\$ 31.34
Napoleon	GLML-29	11-7/8" X 12"	10 pc/box	34	\$ 31.34
Renaissance	GLML-93	11-7/8" X 12"	10 pc/box	34	\$ 31.34
Miro	GLML-95	11-7/8" X 12"	10 pc/box	34	\$ 31.34

Duratile is all non-stock / special order. Please allow 3 - 5 days for delivery.

Modular	Field Tile			Mosaic	Trim			
				2 x 2 Square Mosaic	Cove Base	Cove Base In Angle	Cove Base Out Angle	Single Bullnose
								
6 1/2" x 6 1/2"	13" x 13"	20" x 20"	13" x 13"	6" x 8"	1" x 6"	1" x 6"	3x13	

PRODUCTS, SIZES, CODES & PRICING

NAMES (colors)								
Desert Shade (beige)	R694 N2	R689 N	R676	AF2K	AH3M	AH3T	AH3Z	R699
Garden Shade (green/verde)	RE00 N2	RD99 N	RE01	AF2N	AH3Q	AH3W	AH34	A364
Flaming Sun (rust/rosa)	R693 N2	R688 N	R675	AF2J	AH3L	AH3S	AH3Y	R698
Forest Light (noce)	R695 N2	R690 N	R677	AF2L	AH3N	AH3U	AH32	R700
Moon Light (white/bianco)	R692 N2	R687 N	R674	AF2H	AH3K	AH3R	AH3X	R697
Solar Coat (giallo/gold)	R696 N2	R691 N	R686	AF2M	AH3P	AH3V	AH33	R701

PRICING	sq. ft.	sq. ft.	sq. ft.	sq. ft.	pc	pc	pc	pc
	\$4.10	\$3.78	\$4.20	\$24.16	\$7.88	\$12.48	\$12.48	\$5.52

WEIGHTS, QUANTITIES & DIMENSIONS

WEIGHTS								
Carton (lbs.)	42	62	79	33	26	2	2	1
Pallet (lbs.)	2142	2728	1896	1755				
QUANTITIES								
Tile per Carton	36	13	6	10	24	6	6	1
Cartons per Pallet	51	44	24	45				
DIMENSIONS								
One Carton (sq. ft.)	10.55	15.52	16.15	11.94				
One Pallet (sq. ft.)	538.05	682.88	387.60	536.85				

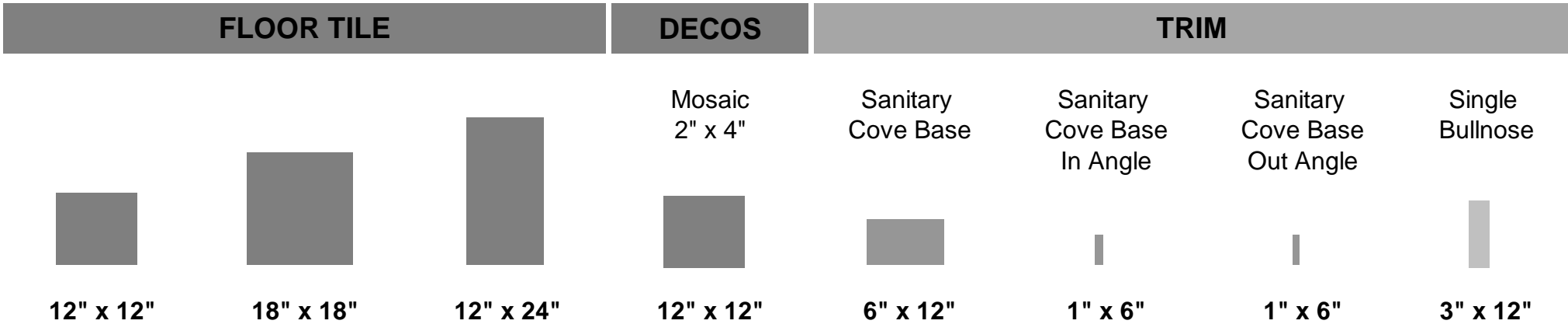

PRODUCTS, SIZES, CODES & PRICING

NAMES (colors)								
Basic Black	UL59	UL5J	ULAZ	ULBA	UL6F	UL66	UL6T	UL5U
Blissful Brown	UL5A	UL5K	ULB2	ULBB	UL6H	UL67	UL6U	UL5V
Graceful Grey	UL5D	UL5N	ULB3	ULBC	UL6N	UL6A	UL6X	UL5Y
Simplistic Smoke	UL5F	UL5R	ULB4	ULBD	UL63	UL6Q	UL6Z	UL6C
Trendy Taupe	UL5G	UL5S	ULB5	ULBE	UL64	UL6R	UL72	UL6D
Wondrous White	UL5H	UL5T	ULB6	ULBF	UL65	UL6S	UL73	UL6E
PRICING	sq. ft.	sq. ft.	sq. ft.	pc	pc	pc	pc	pc
	\$4.06	\$4.38	\$4.70	\$20.94	\$11.02	\$16.00	\$16.00	\$5.52

WEIGHTS, QUANTITIES & DIMENSIONS

WEIGHTS								
Carton (lbs.)	50	66	57	45	26	2	2	21
Pallet (lbs.)	2531	2156	2324					
QUANTITIES								
Tile per Carton	16	8	6	10	12	6	6	20
Cartons per Pallet	48	32	40					
DIMENSIONS								
One Carton (sq. ft.)	15.50	17.44	11.63					
One Pallet (sq. ft.)	744.00	558.08	465.20					



FLOOR TILE ¹								DECORATIVE OPTIONS ¹								TRIM ²
Matte	Matte	Matte	Rock	Rock	Rock	Ridged		Puzzle Mosaic Matte	Strip Mosaic Matte	Random Strip Mosaic Matte	Wave Mosaic Rock	Strip Mosaic Matte	Multi-Strip Mosaic Matte	Stacked Mosaic Matte	Bullnose	
12" x 24" (30 x 60 cm)	24" x 24" (60 x 60 cm)	24" x 48" (60 x 120 cm)	12" x 24" (30 x 60 cm)	24" x 24" (60 x 60 cm)	24" x 48" (60 x 120 cm)	12" x 24" (30 x 60 cm)		12" x 12" (30 x 30 cm)	12" x 12" (30 x 30 cm)	12" x 12" (30 x 30 cm)	12" x 24" (30 x 60 cm)	12" x 24" (30 x 60 cm)	12" x 24" (30 x 60 cm)	12" x 24" (30 x 60 cm)	2.75"x24"	

PRODUCTS, SIZES, CODES & PRICING

NAMES (colors)															
Ardesia	MDTY	MDTX N						MF2X ³	MF2Z ³						MF20
Luserna		MHNO N		MHNS	MHO0 N	MHO1						MJ3N ³			MJ4Q
Malaga	M6QY	M6QX N	M6QV							M6Q4 ³	M6Q2 ³				M6Q0
Piasentina	MDTU	MDTV N	M6T4									M82A ³			MF23
Pierre Bleue	MHO8	MHO9 N	MHOA		MHOB N								MJ3Q ³		MJ4S
Quarzite	MHO2	MHO3 N	MHO4	MHO5	MHO6 N	MHO7						MJ3M ³		MJ3L ³	MJ4R
Serena	M7ZP	M7ZQ N	M7ZR				M7ZT					MF25 ³			MF27
PRICING	sq. ft.	sq. ft.	sq. ft.	sq. ft.	sq. ft.	sq. ft.	sq. ft.	piece	piece	piece	piece	piece	piece	piece	piece
	\$9.04	\$9.04	\$9.38	\$9.04	\$9.04	\$9.38	\$9.04	\$55.12	\$33.08	\$33.08	\$41.90	\$41.90	\$41.90	\$63.94	\$12.48

WEIGHTS, QUANTITIES & DIMENSIONS

WEIGHTS															
Carton (lbs.)	50	57	79	49	57	79	50	19	19	19	21	39	39	39	31
Pallet (lbs.)	2400	2280	2370	2352	2280	2370	2400								
QUANTITIES															
Tile per Carton	5	3	2	5	3	2	5	4	4	4	4	4	4	4	13
Cartons per Pallet	48	40	30	48	40	30	48								
DIMENSIONS															
One Carton (sq. ft.)	9.69	11.63	15.5	9.69	11.63	15.5	9.69								
One Pallet (sq. ft.)	465.12	465.20	465.00	465.12	465.20	465.00	465.12								

SHADE VARIATION, APPLICATIONS & TECHNICAL FEATURES

¹Due to size fluctuation, all measurements given are nominal. Where strict accuracy is required, please refer to actual tile samples.
²Trim is available in all colors, suggested for interior residential applications only and made to complement Modular and Field Tile (see Trim for frost resistance characteristics).

³Special order only.



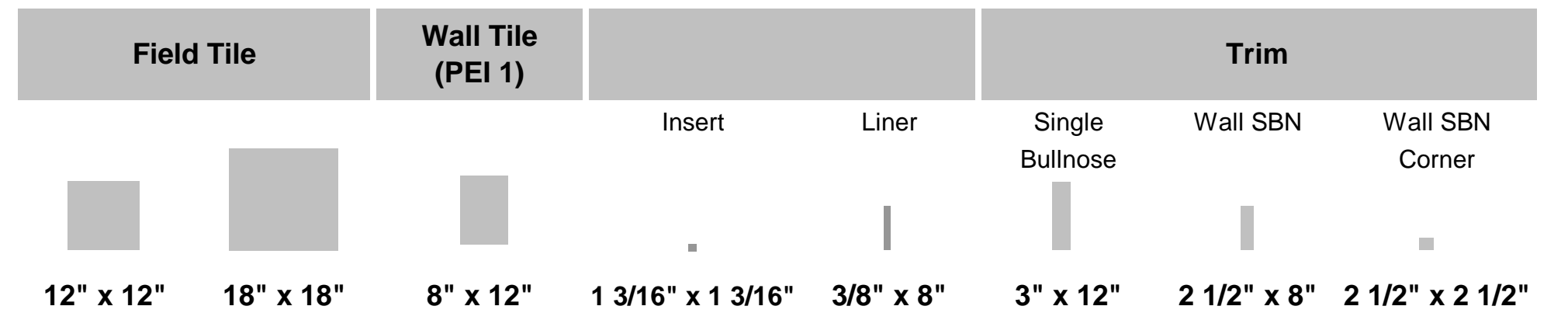

PRODUCTS, SIZES, CODES & PRICING

NAMES (colors)								
Forest Beige (beige)	UF59	UF6C	UF6J			UF6F	UF6M	UF6Q
Forest Green (green)	UF6A	UF6D	UF6K			UF6G	UF6N	UF6R
Forest Noce (brown)	UF6B	UF6E	UF6L			UF6H	UF6P	UF6S
Glass Gold				UF6W	UF6T			
Glass Green				UF6X	UF6U			
Glass Orange				UF6Y	UF6V			
PRICING	sq. ft.	sq. ft.	sq. ft.	pc	pc	pc	pc	pc
	\$3.10	\$3.30	\$3.74	\$4.84	\$15.12	\$4.72	\$3.84	\$4.84

WEIGHTS, QUANTITIES & DIMENSIONS

WEIGHTS								
Carton (lbs.)	50	63	50	1	2	21	10	2
Pallet (lbs.)	2400	2016	3000					
QUANTITIES								
Tile per Carton	15	7	25	24	12	20	20	20
Cartons per Pallet	48	32	60					
DIMENSIONS								
One Carton (sq. ft.)	14.53	15.26	16.50					
One Pallet (sq. ft.)	697.44	488.32	990					



MODULAR TILE ¹									TRIMS ²				
Matte Rectified	Matte Rectified	Matte Rectified	Matte Rectified	Matte Rectified	Polished Rectified	Polished Rectified	Polished Rectified	Rock Rectified	Single Bullnose	Cove Base Slip	Cove Base In Angle	Cove Base Out Angle	
8" x 8" (20 x 20 cm)	12" x 12" (30 x 30 cm)	12" x 24" (30 x 60 cm)	16" x 16" (40 x 40 cm)	24" x 24" (60 x 60 cm)	12" x 12" (30 x 30 cm)	16" x 16" (40 x 40 cm)	24" x 24" (60 x 60 cm)	12" x 12" (30 x 30 cm)	4" x 12" (10 x 30 cm)	6" x 12" (15 x 30 cm)	1" x 6" (2.5 x 10 cm)	1" x 6" (2.5 x 10 cm)	

PRODUCTS, SIZES, CODES & PRICING

LEVEL 1	NAMES (colors)													
	Grigio Chiaro_GR (Serizzo)	MRU2 ³	MRTC	MJBX ³	MRSV	MJD6 ³	MRTD	MRSW	MRSJ ³	MRV3	MWLJ	UK5G	UK5T	UK66
	Grigio Medio_GR (Malaga)	M7KZ ³	M7JR	MJBY	M7KN	MJD7	M7JW	M7KR	M7KX	M7J0	M7NH	UK5H	UK5U	UK67
	Grigio Scuro_GR (Emerald)	MRU4 ³	MRTE	MJBZ	MRSX	MJD8	MRTF	MRSY	MSXV	M7JZ	MWLK	UK5J	UK5V	UK68
	Panna_GR (Dakota)	MRU8 ³	MRTJ	MJBW ³	MRSZ	MJD5 ³	MRTK	MRT0	MRSK ³	M1W7	MWLM	UK5K	UK5W	UK69
	Sabbia_GR (Amarelo)	MRTW ³	MRT5	MJCB ³	MSY0	MJD9 ³	MRT6	MSY1	MSXT ³	MRV0	MWLF	UK5L	UK5X	UK6A
	Tortora_GR		M7JT				M7JY				M7NK	UK5M	UK5Y	UK6B
PRICING	sq. ft.	sq. ft.	sq. ft.	sq. ft.	sq. ft.	sq. ft.	sq. ft.	sq. ft.	sq. ft.	per piece	per piece	per piece	per piece	
	\$4.32	\$4.32	\$4.64	\$4.98	\$6.18	\$7.72	\$8.06	\$9.38	\$4.42	\$4.98	\$12.12	\$12.48	\$12.48	

LEVEL 2	NAMES (colors)													
	Antracite_GR (Special Anthracite)		MKMZ	MJBV	M7KP	MJD4	M7JX	M7KT	M7KY		KXQR	UK5C	UK5P	UK62
	Cotto_GR (Capao)		MRT1				MRT2				MWLD	UK5F	UK5S	UK65
	PRICING	sq. ft.	sq. ft.	sq. ft.	sq. ft.	sq. ft.	sq. ft.	sq. ft.	sq. ft.	sq. ft.	per piece	per piece	per piece	per piece
	n/a	\$4.42	\$4.98	\$5.30	\$6.84	\$8.06	\$8.38	\$9.92	n/a	\$5.08	\$12.12	\$12.48	\$12.48	

LEVEL 3	NAMES (colors)													
	Bianco_GR		M7JQ	MJBU ³	M7KM	MJCS ³	M7JV	M7KQ	M7KW ³		M7NG	UK5D	UK5Q	UK63
	Blu_GR		M7JP				M7JU				M7NJ	UK5E	UK5R	UK64
	Verde_GR (Marina)		MRTL				MRTM				MWLN	UK5N	UK5Z	UK6C
PRICING	sq. ft.	sq. ft.	sq. ft.	sq. ft.	sq. ft.	sq. ft.	sq. ft.	sq. ft.	sq. ft.	per piece	per piece	per piece	per piece	
	n/a	\$4.76	\$5.30	\$5.52	\$7.50	\$8.38	\$8.72	\$10.26	n/a	\$5.30	\$12.12	\$12.48	\$12.48	

WEIGHTS, QUANTITIES & DIMENSIONS

WEIGHTS													
Carton (lbs.)	48	59	59	62	76	51	55	76	57	37	45	2	2
Pallet (lbs.)	2592	2360	2832	2976	2280	2040	2640	2280	2280				
QUANTITIES													
Tile per Carton	30	15	6	8	4	15	8	4	15	30	25	4	4
Cartons per Pallet	54	40	48	48	30	40	48	30	40				
DIMENSIONS													
One Carton (sq. ft.)	12.920	14.53	11.63	13.78	15.50	14.53	13.78	15.50	14.53				
One Pallet (sq. ft.)	697.68	581.20	558.24	661.44	465.00	581.20	661.44	465.00	581.20				

SHADE VARIATION, APPLICATIONS & TECHNICAL FEATURES

¹Due to size fluctuation, all measurements given are nominal. Where strict accuracy is required, please refer to actual tile samples.
²Available in Matte finish, used for all finishes

³Special order only.

Field Tile



5" x 20"

PRODUCTS, SIZES, CODES & PRICING

NAMES (colors)

Beige	M7UK
Black	M7UP
Brown	M7UM
Walnut	M7UN

PRICING

sq.ft.
\$5.32

WEIGHTS, QUANTITIES & DIMENSIONS

WEIGHTS

Carton (lbs.)	40
Pallet (lbs.)	2880

QUANTITIES

Tile per Carton	16
Cartons per Pallet	72

DIMENSIONS

One Carton (sq. ft.)	10.76
One Pallet (sq. ft.)	774.72

Sunnyvale, TX

FLOOR TILE

Rectified Rectified



6" x 36"



9" x 36"





PRODUCTS, SIZES, CODES & PRICING

NAMES (colors)		
Chord (black/cherry)	ULKK	ULKP
Note (grey brown)	ULKL	ULKQ
Pitch (red brown)	ULKM	ULKR
Tone (white)	ULKN	ULKS
PRICING		
	sq. ft.	sq. ft.
	\$8.16	\$7.68

WEIGHTS, QUANTITIES & DIMENSIONS

WEIGHTS		
Carton (lbs.)	63	63
Pallet (lbs.)	2512	2323
QUANTITIES		
Tile per Carton	9	6
Cartons per Pallet	39	36
DIMENSIONS		
One Carton (sq. ft.)	12.75	13.01
One Pallet (sq. ft.)	497.25	468.36

Florence, AL

Field Tile	Trim		
	Sanitary Cove Base	Sanitary Cove Base In Angle	Sanitary Cove Base Out Angle
			
12" x 12"	6" x 8"	1" x 6"	1" x 6"

PRODUCTS, SIZES, CODES & PRICING

NAMES (colors)

Colori Black	UD37	UD3D	UD3L	UD3T
Colori Blue	UD38	UD3E	UD3M	UD3U
Colori Brown	UD39	UD3F	UD3N	UD3V
Colori Green	UD3A	UD3G	UD3P	UD3W
Colori White	UD3B	UD3H	UD3Q	UD3X
Colori Yellow	UD3C	UD3J	UD3R	UD3Y
Crayons Red	UQ00	UD3K	UD3S	UD3Z

PRICING

	sq. ft.	pc	pc	pc
	\$3.14	\$10.50	\$14.70	\$14.70
Crayons Red	\$4.74	\$10.50	\$14.70	\$14.70

WEIGHTS, QUANTITIES & DIMENSIONS

WEIGHTS







Carton (lbs.)	50	26	1	1
Pallet (lbs.)	2400			

QUANTITIES

Tile per Carton	15	24	6	6
Cartons per Pallet	48			

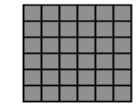
DIMENSIONS

One Carton (sq. ft.)	14.53			
One Pallet (sq. ft.)	697.44			

Modular		Field	Mosaics			Trim
			3" x 3"	Random	Fan	Single Bullnose
						
6" x 6"	6" x 12"	12" x 12"	12" x 12"	12" x 12"	52" x 30"	3" x 12"

PRODUCTS, SIZES, CODES & PRICING

NAMES (colors)

Antracite	M6YH	M6YE	M6YA	M6ZM	M6ZQ	M6ZU	M6ZX
Rosso	M6YF	M6YC	M6X8	M6ZK	M6ZN	M6ZR	M6ZV
Verde	M6YG	M6YD	M6X9	M6ZL	M6ZP	M6ZT	M6ZW

PRICING

sq. ft.	sq. ft.	sq. ft.	pc	pc	pc	pc
\$9.30	\$9.30	\$6.78	\$18.12	\$34.50	\$188.86	\$5.36

WEIGHTS, QUANTITIES & DIMENSIONS

WEIGHTS

Carton (lbs.)	38	38	54	17	17	21	22
Pallet (lbs.)	2128	2280	2160	1360	1020	420	

QUANTITIES

Tile per Carton	38	18	13	4	4	1	20
Cartons per Pallet	56	60	40	80	60	20	

DIMENSIONS

One Carton (sq. ft.)	8.60	8.43	12.59	3.88	3.88	6.67	
One Pallet (sq. ft.)	481.60	505.80	503.60	310.40	232.80	133.40	

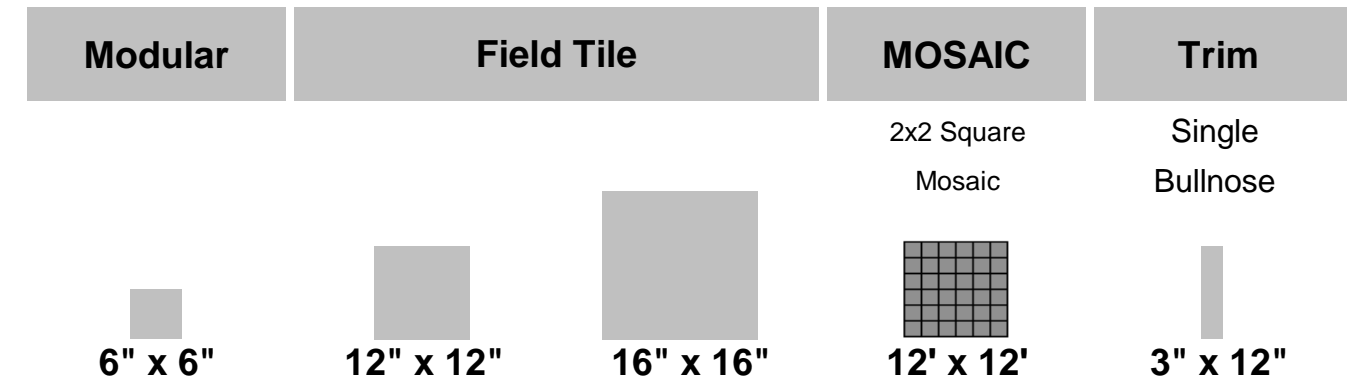









PRODUCTS, SIZES, CODES & PRICING

NAMES (colors)					
Black		UE24	UF4P	UH59	
Rust		UE25	UF4Q	UH6A	
Tan		UE26	UF4R	ULBG	UH6B
Mix (black/rust)	UE3P			ULBH	
PRICING	sq. ft.	sq. ft.	sq. ft.	pc	pc
	\$4.62	\$3.16	\$3.68	\$17.32	\$5.52

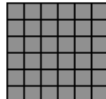
WEIGHTS, QUANTITIES & DIMENSIONS

WEIGHTS					
Carton (lbs.)	35	50	54	39	18
Pallet (lbs.)	2800	2400	1728		
QUANTITIES					
Tile per Carton	40	15	8	10	20
Cartons per Pallet	80	48	32		
DIMENSIONS					
One Carton (sq. ft.)	9.70	14.53	13.78		
One Pallet (sq. ft.)	776	697.44	440.96		

Field Tile			Mosaics		Trim		
							
6.5x6.5	13x13	20x20	13x13	2x2	2x13	1x2	3x13

PRODUCTS, SIZES, CODES & PRICING

NAMES (colors)

Beige	AJ8Q	AJ8H	AJ8J	AJ8K	AJ8L	AJ8M	AJ8N	AJ8P
Green	A413	A409	A407	AJ89	AJ8C	AJ8A	AJ8B	A426
Red	A410	A408 N	A406 N	AJ8D	AJ8G	AJ8E	AJ8F	A425

PRICING

sq.ft.	sq.ft.	sq.ft.	pc	pc	pc	pc	pc
\$3.90	\$2.80	\$2.96	\$20.56	\$21.46	\$14.86	\$18.18	\$5.92

WEIGHTS, QUANTITIES & DIMENSIONS

WEIGHTS





Carton (lbs.)	42	58	77	46	40	9	1	25
Pallet (lbs.)	1176	2552	1848					

QUANTITIES

Tile per Carton	36	13	6	9	10	6	4	20
Cartons per Pallet	28	44	24					



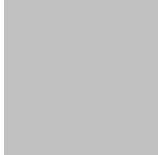
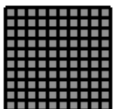
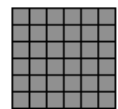
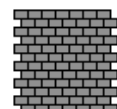



DIMENSIONS

One Carton (sq. ft.)	10.55	15.52	16.15	10.74	11.90			
One Pallet (sq. ft.)	295.40	682.88	387.60					

Modular	Field Tile		Decorative Mosaics			Trim
			13"x13" Mesh Mounted 	13"x13" Mesh Mounted 	13"x13" Mesh Mounted 	Single Bullnose 
6 1/2" x 6 1/2"	13" x 13"	20" x 20"	1" x 1"	2" x 2"	1" x 2"	3" x 13"

PRODUCTS, SIZES, CODES & PRICING

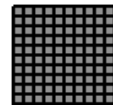
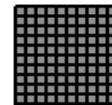
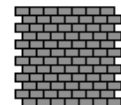
NAMES (colors)							
Chestnut (brown)	UE4R	UE3A N	UE3E	UE4V	UE4Z	UE45	UE3J
Ochre (gold)	UE4S	UE3B N	UE3F	UE4W	UE42	UE46	UE3K
Sage (green)	UE4T	UE3C N	UE3G	UE4X	UE43	UE47	UE3M
Taupe	UE4U	UE3D N	UE3H	UE4Y	UE44	UE48	UE3N
PRICING	sq. ft.	sq. ft.	sq. ft.	pc	pc	pc	pc
	\$5.04	\$3.78	\$4.20	\$35.70	\$22.06	\$29.40	\$5.88
WEIGHTS							
Carton (lbs.)	42	73	79	33	39	36	18
Pallet (lbs.)	2131	2774	1896				
QUANTITIES							
Tile per Carton	36	15	6	10	10	10	20
Cartons per Pallet	51	38	24				
DIMENSIONS							
One Carton (sq. ft.)	10.55	17.90	16.15				
One Pallet (sq. ft.)	538.05	680.20	387.60				

Field Tile				Mosaics			Trim
							
4" x 20"	10" x 20"	13" x 13"	20" x 20"	1" x 1"	1" x 1"	1" x 3"	3" x 13"

PRODUCTS, SIZES, CODES & PRICING

NAMES (colors)

Avorio	UH5U	UH6F	UH5J	UH5P	UH6L	UH6W	UH6R	UH62
Beige	UH5V	UH6G	UH5K	UH5Q	UH6M	UH6X	UH6S	UH63
Blu	UH5Y	UH6K	UH5N	UH5T	UH6Q	UH61	UH6V	UH66
Noce	UH5W	UH6H	UH5L	UH5R	UH6N	UH6Y	UH6T	UH64
Oro	UH5X	UH6J	UH5M	UH5S	UH6P	UH6Z	UH6U	UH65

PRICING

sq. ft.	sq. ft.	sq. ft.	sq. ft.	pc	pc	pc	pc
\$5.98	\$5.98	\$3.98	\$4.20	\$26.78	\$50.24	\$26.78	\$4.88

WEIGHTS, QUANTITIES & DIMENSIONS

WEIGHTS

Carton (lbs.)	56	64	73	79	39	33	39	21
Pallet (lbs.)	2016	1792	2774	1896				



QUANTITIES

Tile per Carton	20	10	13	6	10	10	10	20
Cartons per Pallet	36	28	38	24				

DIMENSIONS

One Carton (sq. ft.)	10.76	13.46	15.52	16.15	11.74	11.74	11.74	5.42
One Pallet (sq. ft.)	387.36	376.88	589.76	387.60				



FLOOR TILE ¹		TRIM ²
Natural Matte	Smooth Polished	Single Bullnose
		
12" x 12" (30 x 30 cm)	12" x 12" (30 x 30 cm)	4" x 12" (10 x 30 cm)

PRODUCTS, SIZES, CODES & PRICING

LEVEL 1	NAMES (colors)			
	Antracite_K	M7M4	M7NA	M7PJ
	Grigio Medio_K	M7M3	M7M9	M7PH
	Panna_K (Coral)	MWG6	MWG8	MWGA
	Sabbia_K	M7M6	M7ND	M7PL
	Tortora_K	M7M7	M7NE	M7PM
PRICING				
	sq. ft.	sq. ft.	piece	
	\$4.64	\$7.72	\$4.98	

LEVEL 2	NAMES (colors)			
	Bianco_K	M7M2	M7M8	M7PG
	Blu_K	M7M5	M7NC	M7PK
PRICING				
	sq. ft.	sq. ft.	piece	
	\$5.30	\$8.38	\$5.30	

WEIGHTS, QUANTITIES & DIMENSIONS

WEIGHTS			
Carton (lbs.)	62	51	37
Pallet (lbs.)	2480	2040	
QUANTITIES			
Tile per Carton	15	15	30
Cartons per Pallet	40	40	
DIMENSIONS			
One Carton (sq. ft.)	14.53	14.53	
One Pallet (sq. ft.)	581.20	581.20	

SHADE VARIATION, APPLICATIONS & TECHNICAL FEATURES

¹Due to size fluctuation, all measurements given are nominal. Where strict accuracy is required, please refer to actual tile samples.

²Available in Matte finish, used for all finishes



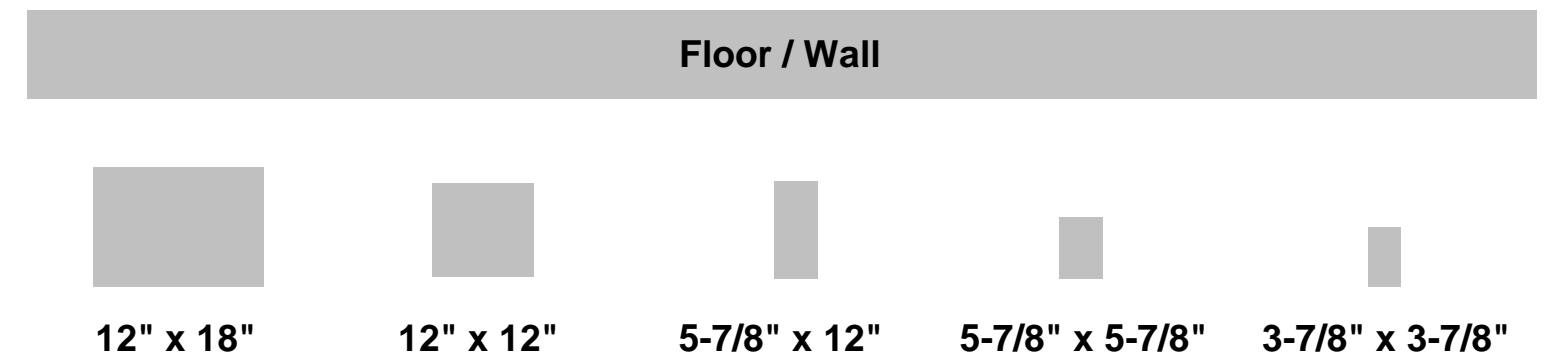





PRODUCTS, SIZES, CODES & PRICING

NAMES (colors)					
Surbo BI (bianco)	3Y79	3Y82	3Y85	3Y88	3Y91
Porfido GR (gray)	2X54	2X51	2X57	2X60	2X80
Trani BG (beige)	3Y77	3Y80	3Y83	3Y86	3Y89
Porfido RS (rust)	2X52	2X49	2X55	2X58	2X78
Borriol BR (brown)	3Y78	3Y81	3Y84	3Y87	3Y90
Basalto NE (nero)	2X53	2X50	2X56	2X59	2X79

PRICING	sq. ft.	sq. ft.	sq. ft.	sq. ft.	sq. ft.
	\$7.56	\$7.56	\$7.56	\$9.46	\$16.00

WEIGHTS, QUANTITIES & DIMENSIONS

WEIGHTS					
Carton (lbs.)	59	50	35	39	23
Pallet (lbs.)	2006	2000	2100	2184	1840
QUANTITIES					
Tiles per Carton	9	12	17	34	50
Cartons per Pallet	34	40	60	56	80
DIMENSIONS					
One Carton (sq. ft.)	13.08	11.63	7.69	7.69	4.86
One Pallet (sq. ft.)	444.72	465.20	461.40	430.64	388.80

FLOOR TILE			DECOS
Rectified	Rectified	Rectified	Strip Mosaic
			
12" x 24"	24" x 24"	24" x 48"	12" x 12"







PRODUCTS, SIZES, CODES & PRICING

NAMES (colors)				
Lifestyle Anthracite AN	R26Q	R26G	R28U	R2CX
Lifestyle Beige BG	R26N	R26E	R28S	R2CY
Lifestyle White BI	R26M	R26D	R28R	R2CV
Lifestyle Gray GR	R26P	R26F	R28T	R2CW
PRICING	sq. ft.	sq. ft.	sq. ft.	sq. ft.
	\$8.34	\$8.34	\$8.98	\$39.70

WEIGHTS, QUANTITIES & DIMENSIONS

WEIGHTS				
Carton (lbs.)	49	56	77	22
Pallet (lbs.)	2352	2240	2310	1760
QUANTITIES				
Tile per Carton	5	3	2	4
Cartons per Pallet	48	40	30	80
DIMENSIONS				
One Carton (sq. ft.)	9.69	11.63	15.50	3.88
One Pallet (sq. ft.)	465.12	465.20	465.00	310.40

Florence, AL

DECOS					
Chair Rail	Pencil Liner	Ridged Liner	Wave Liner	Link Liner	Dot Liner
					
1-7/8"x 13"	5/8"x 13"	9/16"x 13"	3/4"x 13"	9/16"x 13"	1-7/8"x 13"

PRODUCTS, SIZES, CODES & PRICING

NAMES (colors)						
Bronze	ULLM	ULLP	ULLR	ULLT	ULLV	ULLX
Pewter	ULLN	ULLQ	ULLS	ULLU	ULLW	ULLY
PRICING	pc	pc	pc	pc	pc	pc
	\$15.60	\$12.44	\$12.44	\$12.44	\$12.44	\$12.76

WEIGHTS, QUANTITIES

WEIGHTS						
Carton (lbs.)	11	3	2	3	2	7
QUANTITIES						
Tile per Carton	10	10	10	10	10	10

Sunnyvale, TX



FLOOR TILE ¹									DECORATIVE OPTIONS ¹		
Brushed Rectified	Brushed Rectified	Matte Rectified	Matte Rectified	Matte Rectified	Rock Rectified	Rock Rectified	Rock Rectified		Modular Mosaic	Strip Mesh Mosaic	Grooved Mosaic
12" x 24" (30 x 60 cm)	24" x 24" (60 x 60 cm)	12" x 24" (30 x 60 cm)	24" x 24" (60 x 60 cm)	24" x 48" (60 x 120 cm)	12" x 24" (30 x 60 cm)	24" x 24" (60 x 60 cm)	24" x 48" (60 x 120 cm)		12" x 24" (30 x 60 cm)	12" x 24" (30 x 60 cm)	12" x 24" (30 x 60 cm)

PRODUCTS, SIZES, CODES & PRICING

NAMES (colors)												
Black	M6HH ³	M6HM ³	M68F	M68A	M676	M68P	M68K ³	M68U ³	M6HR ³	M6HY ³	M6H2 ³	
Grey	M6HK ³	M6HP ³	M68H	M68D	M678	M68R	M68M ³	M68W ³	M6HU ³	M6HO ³	M6H4 ³	
Wenge	M6HJ ³	M6HN ³	M68G	M68C	M677	M68Q	M68L ³	M68V ³	M6HT ³	M6HZ ³	M6H3 ³	
White	M6HG ³	M6HL ³	M68E	M679	M675	M68N	M68J ³	M68T ³	M6HQ ³	M6HX ³	M6H1 ³	
PRICING	sq. ft.	sq. ft.	sq. ft.	sq. ft.	sq. ft.	sq. ft.	sq. ft.	sq. ft.	sq. ft.	piece	piece	piece
	\$9.04	\$9.04	\$9.04	\$9.04	9.38	\$9.04	\$9.04	\$9.38	\$110.25	\$242.56	\$77.18	

WEIGHTS, QUANTITIES & DIMENSIONS

WEIGHTS											
Carton (lbs.)	49	79	51	79	79	51	77	79	39	19	39
Pallet (lbs.)	2352	2370	2448	2370	2370	2448	2310	2370			
QUANTITIES											
Tile per Carton	5	4	5	4	2	5	4	2	4	2	4
Cartons per Pallet	48	30	48	30	30	48	30	30			
DIMENSIONS											
One Carton (sq. ft.)	9.69	15.50	9.69	15.50	15.50	9.69	15.50	15.50			
One Pallet (sq. ft.)	465.12	465.00	465.12	465.00	465.00	465.12	465.00	465.00			

SHADE VARIATION, APPLICATIONS & TECHNICAL FEATURES

¹Due to size fluctuation, all measurements given are nominal. Where strict accuracy is required, please refer to actual tile samples.
²Available in Matte finish, used for all finishes

³Special order only.



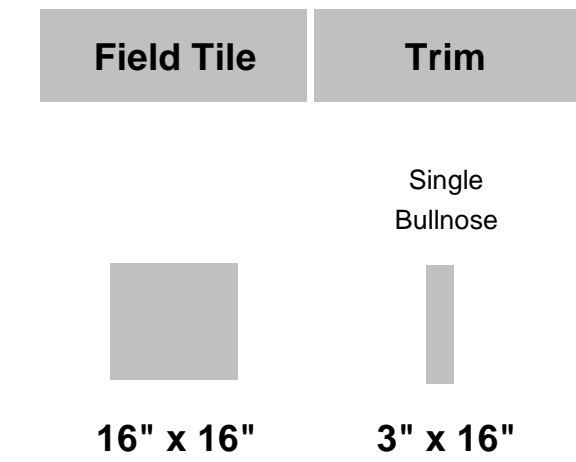

PRODUCTS, SIZES, CODES & PRICING

NAMES (colors)		
Leaf (light brown)	UG6Q	UGAA
Snow (white)	UG6R	UGAB

PRICING	sq. ft.	pc
	\$2.82	\$6.82

WEIGHTS, QUANTITIES & DIMENSIONS

WEIGHTS		
Carton (lbs.)	64	39
Pallet (lbs.)	3552	

QUANTITIES		
Tile per Carton	9	20
Cartons per Pallet	48	

DIMENSIONS		
One Carton (sq. ft.)	15.50	
One Pallet (sq. ft.)	744	

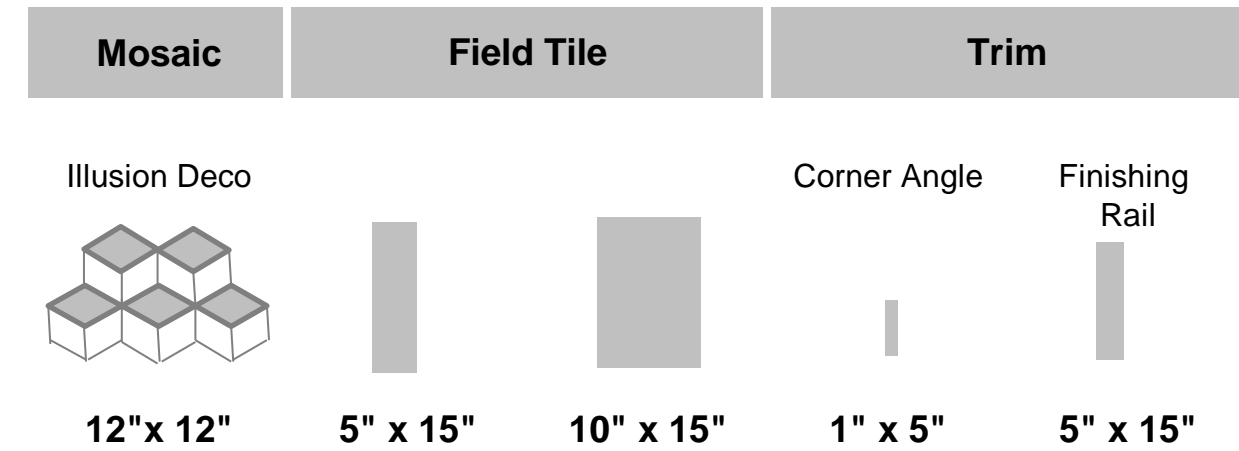

PRODUCTS, SIZES, CODES & PRICING

NAMES (colors)						
Blanco		DBZM	DBBJ	DCCN	DBYM	
Cacao		DBZS	DBBQ	DCCT	DBYS	
Gris		DBZP	DBBL	DCCQ	DBYP	
Marfil		DBZR	DBBN	DCCS	DBYR	
Negro		DBZQ	DBBM	DCCR	DBYQ	
Perla		DBZN	DBBK	DCCP	DBYN	
Grey		DBRW				
Brown		DBRX				
PRICING		pc	sq.ft.	sq.ft.	pc	pc
		\$29.94	\$6.78	\$4.48	\$9.84	\$19.84

WEIGHTS, QUANTITIES & DIMENSIONS

WEIGHTS						
Carton (lbs.)		18	42	42	1	7
Pallet (lbs.)		1080	2184	2268		
QUANTITIES						
Tile per Carton		4	24	12	4	4
Cartons per Pallet		60	52	54		
DIMENSIONS						
One Carton (sq. ft.)		3.88	12.17	12.27		
One Pallet (sq. ft.)		232.80	657.18	662.58		

Unsealed Paver	Sealed Paver	Unsealed Paver	Sealed Paver	Sealed Paver	Unsealed Paver	Sealed Stair Tread	Sealed Diamond	Sealed Paver	Sealed Paver
2"x8"	2"x8"	4"x8"	4"x8"	12"x12"	12"x12"	12"x12"	7.5"x13	5"x5"	6"x12"

PRODUCTS, SIZES, CODES & PRICING

NAMES (colors)										
Antique Red	AR WB28	AR WB28S	AR FB48	AR FB48S						
Buff			BUFF 48	BUFF 48S						
Dark Green			DG 48	DG 48S						
Dove			DOVE 48							
French Chateau		FC WB28S	FC FB48	FC FB48S						
Gray			GRAY 48							
La Rouge			LR FB48	LR FB48S						
Maroon			MAR 48							
Old Boston			OB FB48	OB FB48S						
Old Chicago	OC WB28	OC WB28S	OC FB48	OC FB48S						
Old El Paso		OEP WB28S	OEP FB48	OEP FB48S						
Old St. Louis			OS FB48	OSL FB48S						
Old Santa Fe	OSF WB28	OSF WB28S	OSF FB48	OSF FB48S						
Tuscany Brown					TB 12S		TB 12SST	TB DS	TB 55S	TB 612S
Terra Cotta					TC 12S	TC 12				
Wine Country	WC WB28	WC WB28S	WC FB48	WC FB48S						

PRICING	sq. ft.	sq. ft.	sq. ft.	sq. ft.	sq. ft.	sq. ft.	sq. ft.	sq. ft.	sq. ft.	sq. ft.
	\$5.96	\$8.48	\$5.96	\$8.48	\$8.48	\$6.60	\$12.50	\$7.56	\$8.52	\$7.56

WEIGHTS, QUANTITIES

WEIGHTS										
Carton (lbs.)	62.40	62.40	62.40	62.40	6	6	6	50	60	75
Pallet (lbs.)	2443.60	2443.60	2443.60	2443.60						
Square Foot (lbs.)	5.20	5.20	5.20	5.20	6	6	6			

QUANTITIES										
Tile per Carton					1	1	1	18	64	
Cartons per Pallet	39	39	39	39						

DIMENSIONS										
One Carton (sq. ft.)	12	12	12	12	1	1	1	12.19	11	12
One Pallet (sq. ft.)	468	468	468	468.00						

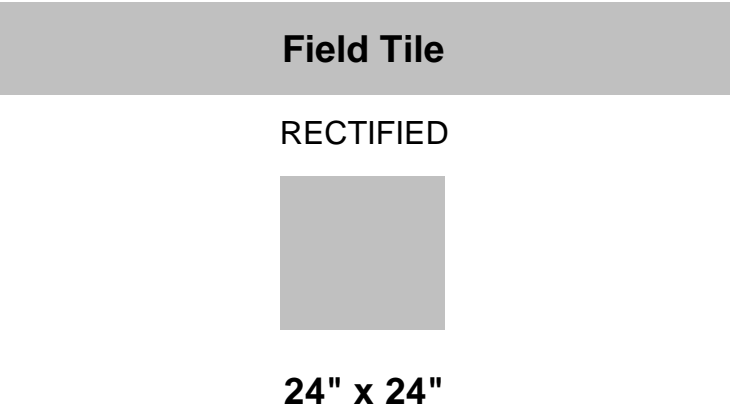

PRODUCTS, SIZES, CODES & PRICING

NAMES (colors)	
Brown	DBME
Caldia	DBMA
Grey	DBMB
Marfil	DBLZ
Zebrino	DBLY
PRICING	
	sq.ft.
	\$11.16

WEIGHTS, QUANTITIES & DIMENSIONS

WEIGHTS	
Carton (lbs.)	62
Pallet (lbs.)	2480
QUANTITIES	
Tile per Carton	3
Cartons per Pallet	40
DIMENSIONS	
One Carton (sq. ft.)	11.63
One Pallet (sq. ft.)	465.20

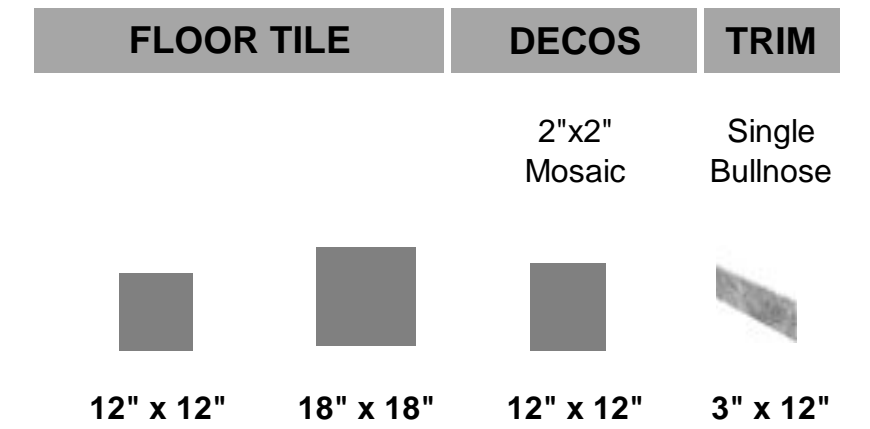







PRODUCTS, SIZES, CODES & PRICING

NAMES (colors)				
New Brunswick (Ivory)	ULCT	ULCX	ULD3	ULD7
Nova Scotia (Rust)	ULCU	ULCY	ULD4	ULD8
Quebec (Walnut)	ULCV	ULCZ	ULD5	ULD9
PRICING	sq. ft.	sq. ft.	pc	pc
	\$2.36	\$2.70	\$17.32	\$4.26

WEIGHTS, QUANTITIES & DIMENSIONS

WEIGHTS				
Carton (lbs.)	50	66	39	21
Pallet (lbs.)	2531	2156		
QUANTITIES				
Tile per Carton	16	8	10	20
Cartons per Pallet	48	32		
DIMENSIONS				
One Carton (sq. ft.)	15.50	17.44		
One Pallet (sq. ft.)	744.00	558.08		

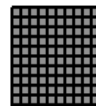
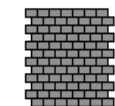
Sunnyvale, TX

Modular	Field Tile			Decorative Mosaic		Decos	Trim
				13"x13" Mesh Mounted	13"x13" Mesh Mounted	Listelli Mesh Mounted	Single Bullnose
							
6 1/2" x 6 1/2" (16.5 x 16.5 cm)	13" x 13" (33.3 x 33.3 cm)	20" x 20" (50 x 50 cm)		1" x 1" (2.5 x 2.5 cm)	1" x 3" (2.5 x 8 cm)	2" x 13" (5 x 33.3 cm)	3" x 13" (8 x 33.3 cm)

PRODUCTS, SIZES, CODES & PRICING

NAMES (colors)

Beige	UH3F	UH27	UH3B	UH3T	UH3X	UH4A	UH3P
Noce	UH3G	UH28	UH3C	UH3U	UH3Y	UH4B	UH3Q
Blu	UH3H	UH29	UH3D	UH3V	UH3Z	UH4C	UH3R
Oro	UH3J	UH3A	UH3E	UH3W	UH32	UH4D	UH3S

PRICING	sq. ft.	sq. ft.	sq. ft.	pc	pc	pc	sq. ft.
	\$5.04	\$3.98	\$4.20	\$26.78	\$26.78	\$20.48	\$4.90

WEIGHTS, QUANTITIES & DIMENSIONS

WEIGHTS

Carton (lbs.)	42	73	79	39	39	6	22
Pallet (lbs.)	2142	2774	1896				

QUANTITIES

Tile per Carton	32	13	6	10	10	6	20
Cartons per Pallet	51	38	24				

DIMENSIONS

One Carton (sq. ft.)	9.38	15.52	16.15				
One Pallet (sq. ft.)	478.38	589.76	367.60				

*Trim is available in all colors and made to complement Modular and Field Tile.

SKU

SIZE

SF / CT

PC / CT

LBS / CT

PRICE

PRODUCTS, SIZES, CODES & PRICING

NAMES (colors)

Quarry Basic Puritan Gray	507 66	6x6x1/2	7	28	40.71	\$	4.42
Metrotread Puritan Gary	57T 66	6x6x1/2	4	28	40.724	\$	4.46
Quarry Basic Puritan Gray Covebase	507 Q3565	6x6		14	21	\$	3.26
Quarry Basic Mayflower Red	310 88	7-5/8x7-5/8x12	7.1	16	36.88	\$	4.42
Sommerset Harvard Square	350 88	7-5/8x7-5/8x1/2	7.1	16	36.88	\$	5.24
Quarry Basic Mayflower Red SBN	310 Q1665	6x6		14	21.00	\$	3.56
Quarry Basic Mayflower Red Covebase	310 Q3565	6x6		14	21.00	\$	3.26
Quarry Basic Mayflower Red Quarter Round	310 Q3565B	6x6		14	21.00	\$	7.38
Quarry Basic Mayflower Red	310 48	3-5/8x7-5/8x12	7.1	32	34.375	\$	5.08
Quarry Basic Mayflower Red	310 66	6x6x1/2	7	28	40.71	\$	4.42
Quarry Basic Commerical Red	31X 66	6x6x1/2	7	28	40.71	\$	4.60
Quarry Basic Commerical Red	31X 88	7-5/8x7-5/8x1/2	7.1	16	36.87	\$	4.60
Quarry Basic Mayflower Red Left Cove	310 QCL3565N	6x6		14	21	\$	5.84
Quarry Basic Mayflower Red Rt. Cove	310 QCR3565N	6x6		14	21.00	\$	5.84
Quarry Basic Adobe Round Top Cove	205 Q3485	4x8		12	18	\$	3.88
Quarry Basic Malibu Beach	15X 66	6x6x1/2	7	28	40.71	\$	4.60
Quarry Basic Boulevard Cove	107 Q3565	6x6		14	21	\$	3.26

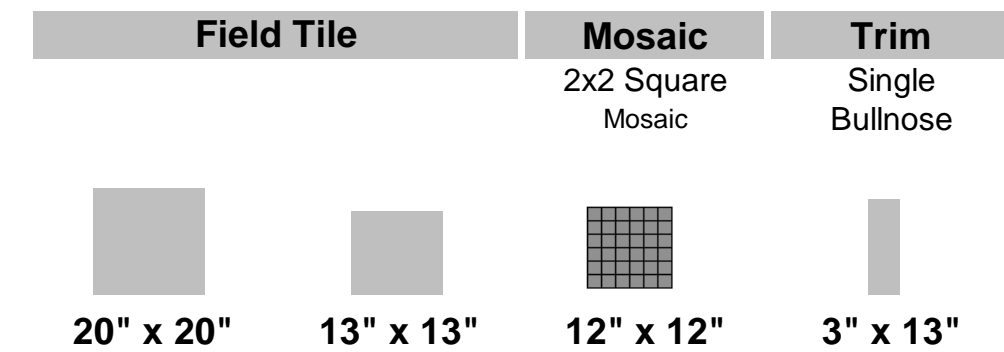

PRODUCTS, SIZES, CODES & PRICING

NAMES (colors)				
Euphoria (lt gray)	AL7A	AL77	AL7D	AL7G
Mystical (brown)	AL79	AL76	AL7C	AL7F
Passion (dk gray)	AL7B	AL78	AL7E	AL7H

PRICING	sq. ft.	sq. ft.	pc	pc
	\$4.70	\$4.38	\$23.16	\$5.96

WEIGHTS, QUANTITIES & DIMENSIONS

WEIGHTS				
Carton (lbs.)	76	60	43	22
Pallet (lbs.)	1824	2640	1935	
QUANTITIES				
Tile per Carton	6	13	10	20
Cartons per Pallet	24	44	45	
DIMENSIONS				
One Carton (sq. ft.)	16.15	15.52	11.90	
One Pallet (sq. ft.)	387.60	682.88	535.50	

Florence, AL

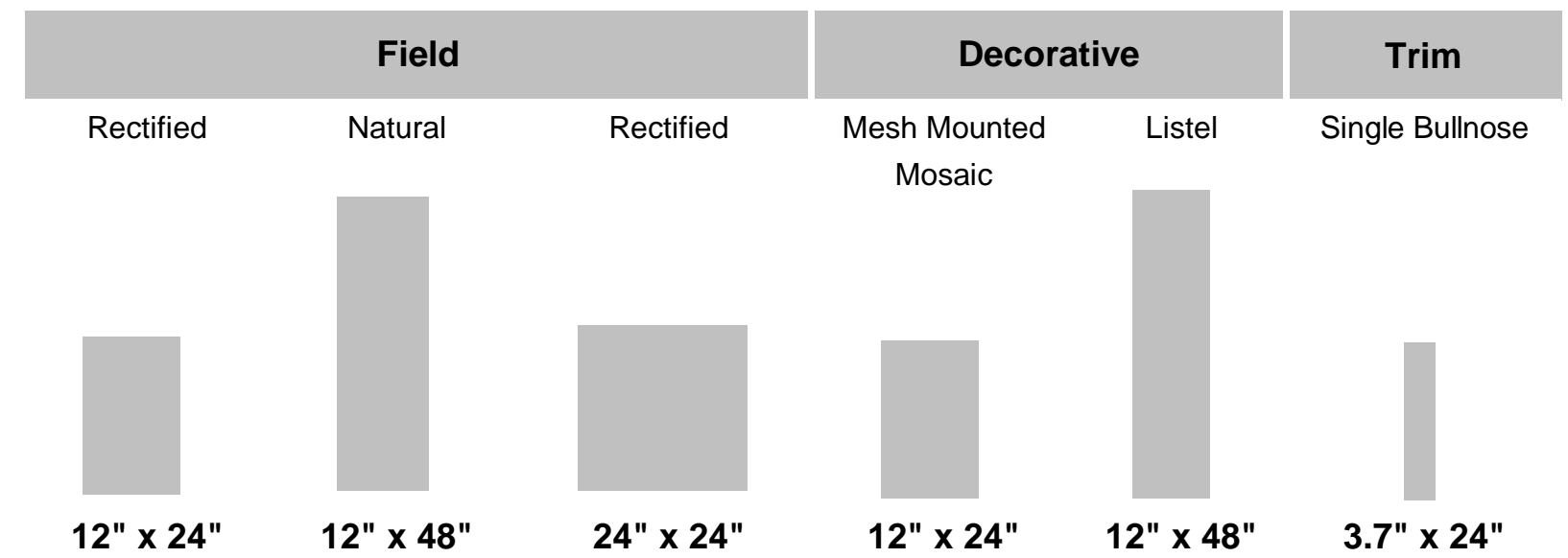

PRODUCTS, SIZES, CODES & PRICING

NAMES (colors)						
Beige BG	R4Q4 N	R4P9	R4P4 N	R5P5		R4W9
Black NE	R4Q7 N	R4Q2	R4P7 N	R5P8	R5P3	R4X2
Brown MA	R4Q5 N	R4Q0	R4P5 N	R5P6	R5P2	R4X0
Red RS	R4Q6 N	R4Q1	R4P6 N	R5P7		R4X1
White BI	R4Q3 N	R4P8	R4P3 N	R5P4	R5P1	R4W8

PRICING	sq. ft.	sq. ft.	sq.ft.	sq. ft.	pc	pc
	\$8.98	\$8.98	\$8.98	\$23.80	\$409.50	\$11.04

WEIGHTS, QUANTITIES & DIMENSIONS

WEIGHTS						
Carton (lbs.)	48	59	59	38	41	39
Pallet (lbs.)	2304	1180	2360	798	492	
QUANTITIES						
Tile per Carton	5	3	3	4	2	13
Cartons per Pallet	48	20	40	21	12	
DIMENSIONS						
One Carton (sq. ft.)	9.69	11.63	11.63	7.75	7.75	
One Pallet (sq. ft.)	465.12	232.60	465	162.75	93	

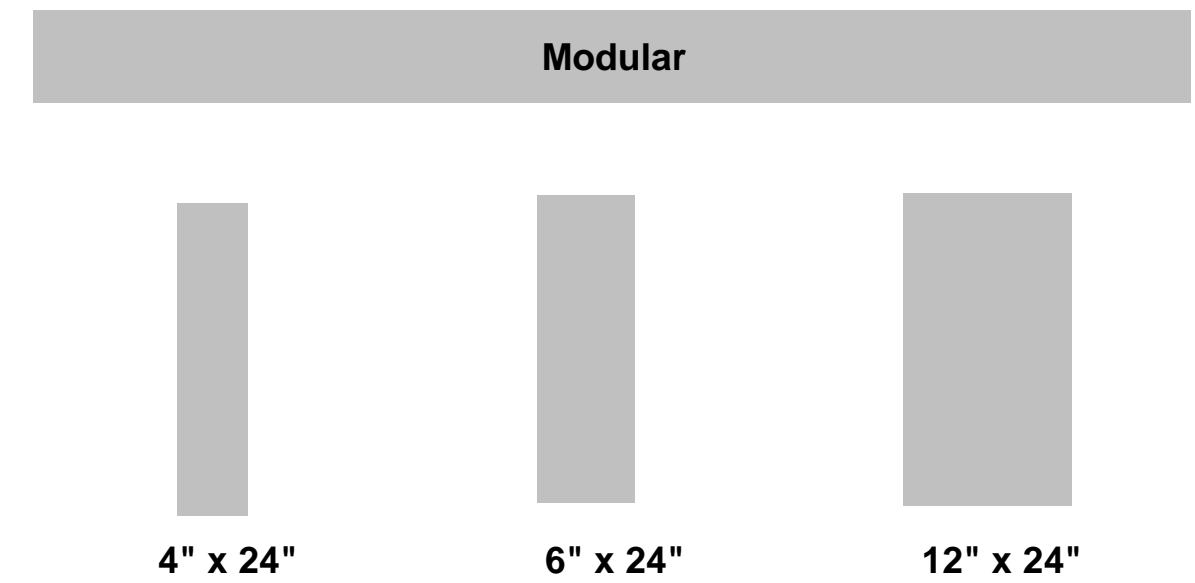

PRODUCTS, SIZES, CODES & PRICING

NAMES (colors)

Ash	UJ3P	UHAJ	UJ3J
Cherry	UJ3Q	UHAK	UJ3K
Ebony	UJ3R	UHAL	UJ3L
Oak	UJ3S	UHAM	UJ3M
Walnut	UJ3T	UJ3H	UJ3N

PRICING

sq. ft.	sq. ft.	sq. ft.
\$5.96	\$5.96	\$5.96

WEIGHTS, QUANTITIES & DIMENSIONS

WEIGHTS

Carton (lbs.)	50	50	50
Pallet (lbs.)	2000	2000	2000

QUANTITIES

Tile per Carton	15	10	5
Cartons per Pallet	40	40	40

DIMENSIONS

One Carton (sq. ft.)	9.32	9.46	9.51
One Pallet (sq. ft.)	372.80	378.40	380.40

Field Tile



12" x 12"

PRODUCTS, SIZES, CODES & PRICING

NAMES (colors)	
Gray	UY6L
Light Brown	UA89
PRICING	
	sq. ft.
	\$2.32

WEIGHTS, QUANTITIES & DIMENSIONS

WEIGHTS	
Carton (lbs.)	51
Pallet (lbs.)	1734
QUANTITIES	
Tile per Carton	15
Cartons per Pallet	34
DIMENSIONS	
One Carton (sq. ft.)	14.53
One Pallet (sq. ft.)	494.02

Wall Tile		
1" x 1"	2" x 2"	4" x 4"

PRODUCTS, SIZES, CODES & PRICING

NAMES (colors)

Floral Pattern



Bronze	UJ6Z	UJ6X	UJ6V
Nickel	UJ6Y	UJ6W	UJ6U
Venetian Bronze	UJ74	UJ72	UJ7Y
Wrought Iron	UJ75	UJ73	UJ7Z

Fleur de Lis Pattern



Bronze	UJ9A	UJ7F	
Nickel	UJ89	UJ7E	
Venetian Bronze	UJ9B	UJ8C	
Wrought Iron	UJ9C	UJ8D	

Diamond Pattern



Bronze	UJ67	UJ65	UJ63
Nickel	UJ66	UJ64	UJ62
Venetian Bronze	UJ8A	UJ78	UJ76
Wrought Iron	UJ8B	UJ79	UJ77

Dot Pattern



Bronze	UJ7B	UJ6T	
Nickel	UJ7A	UJ6S	
Venetian Bronze	UJ7C	UJ68	
Wrought Iron	UJ7D	UJ69	

PRICING

pc	pc	pc
\$3.62	\$4.76	\$13.08

PACKAGING

Tiles per carton	1	1	1
------------------	---	---	---

Wall Tile		
1/2" x 13"	1" x 13"	1-1/2" x 13"

PRODUCTS, SIZES, CODES & PRICING

NAMES (colors)

Pencil Liners 

Bronze	UJ6R
Nickel	UJ6Q
Venetian Bronze	UJ7U
Wrought Iron	UJ7V

Dot Listelli 

Bronze	UJ9E
Nickel	UJ9D
Venetian Bronze	UJ9F
Wrought Iron	UJ9G

Chair Rail 













Bronze	UJ6P
Nickel	UJ6N
Venetian Bronze	UJ7S
Wrought Iron	UJ7T

PRICING	pc	pc	pc
	\$12.44	\$12.44	\$15.60

PACKAGING

Tiles per carton	1	1	1
------------------	---	---	---

Sunnyvale, TX

DECORATIVE OPTIONS											TRIM*
Diamond Insert	Dot Insert	Fleur de Lis Insert	Fleur de Lis Insert with Bronze Inlay	Floral Insert	Weave Insert	Renaissance Insert	Pencil Liner	Dot Listelli	Weave Listelli	Renaissance Border	Chair Rail
											
2" x 2"	2" x 2"	2" x 2"	2" x 2"	2" x 2"	2" x 2"	2" x 2"	.5" x 13"	1" x 13"	1" x 13"	3" x 13"	1 1/2" x 13"

PRODUCTS, SIZES, CODES & PRICING

NAMES (colors)												
Ivory	UL4E	UL4G	UL4Q	UL4S	UL4J	UL4N	UL4L	UL4U	UL4Y	UL4W	UL54	UL52
Noce	UL4F	UL4H	UL4R	UL4T	UL4K	UL4P	UL4M	UL4V	UL4Z	UL4X	UL55	UL53
PRICING	pc	pc	pc	pc	pc	pc	pc	pc	pc	pc	pc	pc
	\$4.76	\$4.76	\$4.76	\$5.86	\$4.76	\$4.76	\$4.76	\$9.38	\$9.38	\$9.38	\$13.80	\$10.48

WEIGHTS, QUANTITIES & DIMENSIONS

WEIGHTS												
Carton (lbs.)	1	1	1	1	1	1	1	3	4	4	4	8
Pallet (lbs.)												
QUANTITIES												
Tile per Carton	8	8	8	8	8	8	8	10	10	10	10	10
Cartons per Pallet												
DIMENSIONS												
One Tile (sq. ft.)	0.024	0.024	0.024	0.024	0.024	0.024	0.024	0.048	0.084	0.084	0.084	0.150
One Carton (sq. ft.)	0.20	0.20	0.20	0.20	0.20	0.20	0.20	0.49	0.85	0.85	0.85	1.50

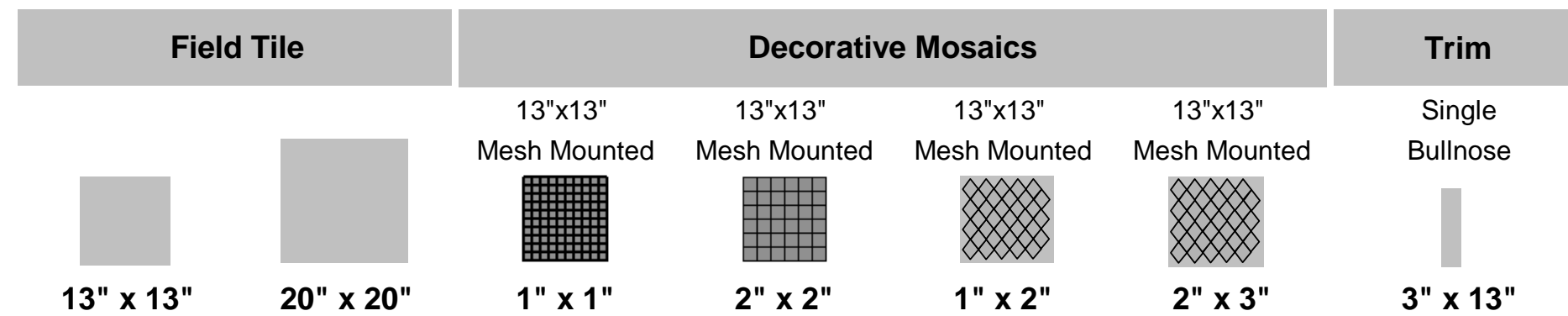

PRODUCTS, SIZES, CODES & PRICING

NAMES (colors)

Acqua (ivory)	FB24 N	FB28	FC2K	FC2P	FC2T	FC2X	FB2C
Argilla (walnut)	FB25 N	FB29	FC2L	FC2Q	FC2U	FC2Y	FB2D
Creta (gray)	FB26 N	FB2A	FC2M	FC2R	FC2V	FC2Z	FB2E
Elios (gold)	FB27 N	FB2B	FC2N	FC2S	FC2W	FC22	FB2F

PRICING

sq. ft.	sq. ft.	pc	pc	pc	pc	pc
\$3.78	\$4.20	\$37.80	\$24.16	\$40.96	\$34.66	\$3.16

WEIGHTS, QUANTITIES & DIMENSIONS

WEIGHTS

Carton (lbs.)	73	79	38	45	38	45	18
Pallet (lbs.)	2774	1896					

QUANTITIES

Tile per Carton	15	6	10	10	10	10	20
Cartons per Pallet	38	24					

DIMENSIONS

One Carton (sq. ft.)	17.90	16.15					
One Pallet (sq. ft.)	680.20	387.60					

Florence, AL

Sierra Madre

Glazed Porcelain Tile
Heavy Shade Variation

PEI 4

Field Tile



12" x 12"



18" x 18"

PRODUCTS, SIZES, CODES & PRICING











NAMES (colors)		
Guadalajara (medium beige)	F35H	F35P
Sonora (beige)	F35K	F35S

PRICING		
	sq. ft.	pc
	\$2.70	\$3.00

WEIGHTS, QUANTITIES & DIMENSIONS

WEIGHTS		
Carton (lbs.)	51	51
Pallet (lbs.)	2,448	1,632
QUANTITIES		
Tile per Carton	15	6
Cartons per Pallet	48	32
DIMENSIONS		
One Carton (sq. ft.)	14.53	13.08
One Pallet (sq. ft.)	697.44	418.56

Florence, AL

FLOOR TILE			DECOS				TRIM			
										
12" x 24"	18" x 36"	20" x 20"	5/8" x 12"	2" x 12"	12" x 12"	12" x 12"	4" x 24"	6" x 12"	1" x 6"	1" x 6"

PRODUCTS, SIZES, CODES & PRICING

NAMES (colors)											
Distinguished (Dark Noce)	ULBL	ULBP	ULBS				ULEW*	ULBV	ULC6	ULBY	ULC3
Elegant (White)	ULBJ	ULBM	ULBQ				ULEU	ULBT	ULC4	ULBW	ULBZ
Sophisticated (Beige)	ULBK	ULBN	ULBR				ULEV	ULBU	ULC5	ULBX	ULC2
Mixed				ULEB	ULEE	ULE8					
PRICING	sq. ft.	sq. ft.	sq. ft.	pc	pc	pc	pc	pc	pc	pc	pc
Level I	\$5.80	\$7.38	\$5.64	\$10.48	\$10.94	\$22.84	\$20.94	\$12.48	\$11.02	\$16.00	\$16.00
Level II -- Distinguished							*\$22.05				

WEIGHTS, QUANTITIES & DIMENSIONS

WEIGHTS											
Carton (lbs.)	57	63	79	3	4	39	39	47	26	2	2
Pallet (lbs.)	2324	2079	1896								
QUANTITIES											
Tile per Carton	6	3	6	9	6	10	10	15	12	6	6
Cartons per Pallet	40	33	24								
DIMENSIONS											
One Carton (sq. ft.)	11.63	13.44	16.15								
One Pallet (sq. ft.)	465.20	443.52	387.60								

Florence, AL



MODULAR TILE ¹				TRIM ²
Natural Rectified	Natural Rectified	Natural Rectified	Lux Rectified	Single Bullnose
12" x 24" (30 x 60 cm)	24" x 24" (60 x 60 cm)	24" x 48" (60 x 120 cm)	24" x 24" (60 x 60 cm)	3" x 24" (7.1 x 60 cm)

PRODUCTS, SIZES, CODES & PRICING

LEVEL 1	NAMES (colors)					
	Acciaio	M6MG	M6K8 N		M6LW ³	M6NZ
	Argilla		M6LH N			M6NV
	Avorio	M6MM	M6LE N	M6M6 ³	M6L1 ³	M6NR
	Bianco	M6MF	M6K7 N	M6M0 ³	M6LV	M6NY
	Cemento	M6MH	M6K9 N	M6M2 ³	M6LX ³	M6NO
	Creta		M6LL N			M6NK
	Fango	M6MR	M6LJ N	M6NA ³	M6L5 ³	M6NW
	Grigio	M6MJ	M6LA N	M6M3 ³	M6LY ³	M6N1
	Marrone		M6LK N			M6NX
	Sabbia		M6LF N			M6NT
	Tortora		M6LG N		M6L3 ³	M6NU
PRICING		sq. ft.	sq. ft.	sq. ft.	sq. ft.	per piece
		\$11.26	\$11.60	\$12.12	\$13.58	\$12.48

LEVEL 2	NAMES (colors)					
	Arancio	M6MZ	M6LR N	M6NJ ³	M6ME ³	M6NQ
	Ardesia	M6MK	M6LC N		M6LZ ³	M6N2
	Giallo	M6MY	M6LQ N		M6MD ³	M6NP
	Nero	M6ML	M6LD N	M6M5 ³	M6L0	M6N3
	Verde		M6LM N			M6NL
	PRICING		sq. ft.	sq. ft.	sq. ft.	sq. ft.
		\$11.90	\$12.12	\$12.78	\$14.24	\$12.70

LEVEL 3	NAMES (colors)					
	Blu	M6MX	M6LP N	M6NG ³	M6MC ³	M6NN
	Rosso	M6MW	M6LN N	M6NF ³	M6MA ³	M6NM
PRICING		sq. ft.	sq. ft.	sq. ft.	sq. ft.	per piece
		\$12.12	\$12.48	\$13.14	\$14.56	\$12.92

WEIGHTS, QUANTITIES & DIMENSIONS

WEIGHTS					
Carton (lbs.)	49	59	80	75	44
Pallet (lbs.)	2352	2360	2400	2250	
QUANTITIES					
Tile per Carton	5	3	2	4	13
Cartons per Pallet	48	40	30	30	
DIMENSIONS					
One Carton (sq. ft.)	9.69	11.63	15.50	15.50	
One Pallet (sq. ft.)	465.12	465.00	465.00	465.00	

SHADE VARIATION, APPLICATIONS & TECHNICAL FEATURES

¹Due to size fluctuation, all measurements given are nominal. Where strict accuracy is required, please refer to actual tile samples.

²Available in Matte finish, used for all finishes

³Special order only.





FLOOR TILE ¹										TRIM ²			
Matte Rectified	Matte Rectified	Matte Rectified	Matte Rectified	Polished Rectified	Rock Rectified	Rock Rectified	Rock Rectified	Rock Rectified		Bullnose *Matte Surface	Cove Base	IN Angle	OUT Angle
4"x24" (10 x 60 cm)	6"x24" (15 x 60 cm)	12" x 24" (30 x 60 cm)	24" x 24" (60 x 60 cm)	24" x 24" (60 x 60 cm)	4"x24" (10 x 60 cm)	6"x24" (15 x 60 cm)	12" x 24" (30 x 60 cm)	24" x 24" (60 x 60 cm)		3" x 24" (8 x 60 cm)	6" x 12" (15 x 30 cm)	1" x 6" (2.5 x 15 cm)	1" x 6" (2.5 x 15 cm)

PRODUCTS, SIZES, CODES & PRICING

LEVEL 1	NAMES (colors)													
	Bianco_N	M833 ³	M838 ³	M83A	M7Q9 N	MJ01 N	M84E ³	M84K ³	M83Y	M85G ³	M842*	UK7Q	UK82	UK8B
	Fango_N	M9Z3 ³	M9Z4 ³	M83E	M824 N	MJ04 N					M845*	UK7R	UK83	UK8C
	Grigio Chiaro_N	M835 ³	M84A ³	M83F	M825 N	MJ05 N	M84G ³	M84M ³	M830	M85J ³	M846*	UK7S	UK84	UK8D
	Grigio Medio_N	M9Z5 ³	M9Z6 ³	M83G	M826 N	MJ06 N					M847*	UK7T	UK85	UK8E
	Grigio Scuro_N	M836 ³	M84C ³	M83H	M827 N	MJ07 N	M84H ³	M84N ³	M831	M9ZV ³	M848*	UK7U	UK86	UK8F
	Sabbia_N	M834 ³	M839 ³	M83C	M7RA N	MJ02 N	M84F ³	M84L ³	M83Z	M85H ³	M843*	UK7W	UK88	UK8H
	Tortora_N	M9Z1 ³	M9Z2 ³	M83D	M7RC N	MJ03 N					M844*	UK7X	UK89	UK8J
PRICING		sq. ft.	sq. ft.	sq. ft.	sq. ft.	sq. ft.	sq. ft.	sq. ft.	sq. ft.	sq. ft.	piece	piece	piece	piece
		\$11.90	\$11.90	\$6.84	\$7.18	\$11.60	\$11.90	\$11.90	\$7.94	\$7.94	\$8.60	\$19.62	\$12.48	\$12.48

LEVEL 2	NAMES (colors)													
	Bianco Puro_N	M9ZZ ³	M9Z0 ³	M829	M7Q8 N	MJ00					M841*	UK7P	UK7Z	UK8A
	Nero_N	M837 ³	M84D ³	M83J	M828 N	MJ08	M84J ³	M84P ³	M832	M9ZW ³	M849*	UK7V	UK87	UK8G
PRICING		sq. ft.	sq. ft.	sq. ft.	sq. ft.	sq. ft.	sq. ft.	sq. ft.	sq. ft.	sq. ft.	piece	piece	piece	piece
		\$12.26	\$12.26	\$7.18	\$7.72	\$12.12	\$12.26	\$12.26	\$8.28	\$8.28	\$7.62	\$19.62	\$12.48	\$12.48

WEIGHTS, QUANTITIES & DIMENSIONS

WEIGHTS

Carton (lbs.)	44	40	50	79	79	44	40	50	79	29	26	2	2
Pallet (lbs.)	1980	2560	2400	2370	2370	1980	2560	2400	2370				

QUANTITIES

Tile per Carton	13	8	5	4	4	13	8	5	4	13	12	6	6
Cartons per Pallet	45	64	48	30	30	45	64	48	30				

DIMENSIONS

One Carton (sq. ft.)	8.40	7.75	9.69	11.63	11.63	8.40	7.75	9.69	15.50				
One Pallet (sq. ft.)	378.55	496.00	465.12	465.00	465.00	378.55	496.00	465.12	465.00				

SHADE VARIATION, APPLICATIONS & TECHNICAL FEATURES

¹Due to size fluctuation, all measurements given are nominal. Where strict accuracy is required, please refer to actual tile samples.

²Available in Matte finish, used for all finishes

³Special order only.



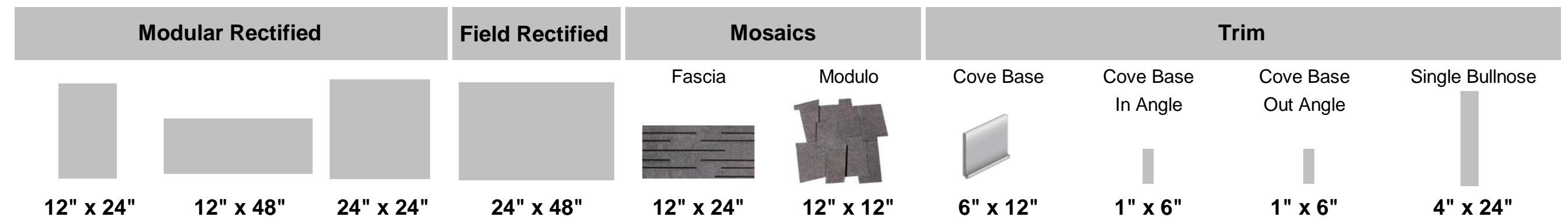

PRODUCTS, SIZES, CODES & PRICING

NAMES (colors)

Anthracite	M6X4	M6YN	M6X0 N	M6XW	M70C	M6Z9	UHCR	UHCV	UHCZ	M70U
Beige	M6X1	M6YK	M6XX N	M6XT	M70E		UHCN	UHCS	UHCW	M70Q
Brown	M6X3	M6YM	M6XZ N	M6XV	M70D	M70A	UHCQ	UHCU	UHCY	M70T
Grey	M6X2	M6YL	M6XY N	M6XU	M70F		UHCP	UHCT	UHCX	M70R

PRICING

sq. ft.	sq. ft.	sq. ft.	sq. ft.	pc	pc	pc	pc	pc	pc
\$8.80	\$11.70	\$8.80	\$11.70	\$110.16	\$142.28	\$14.98	\$11.44	\$11.44	\$12.58

WEIGHTS, QUANTITIES & DIMENSIONS

WEIGHTS

Carton (lbs.)	48	62	58	80	41	20	26	2	2	39
Pallet (lbs.)	2304	1240	2320	2400						

QUANTITIES

Tile per Carton	5	3	3	2	4	4	12	6	6	13
Cartons per Pallet	48	20	40	30						

DIMENSIONS

One Carton (sq. ft.)	9.69	11.63	11.63	15.50						
One Pallet (sq. ft.)	465.12	232.60	465.12	465						

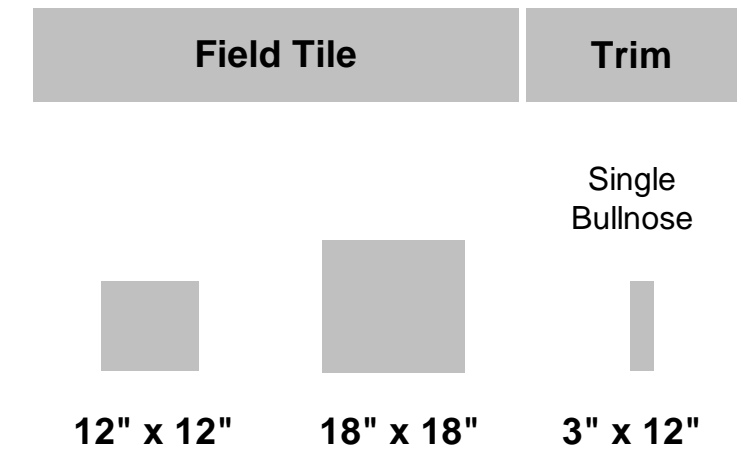

PRODUCTS, SIZES, CODES & PRICING

NAMES (colors)			
Ginger (white/mauve)	UF49	UF5C	UH6C
Nutmeg (brown)	UF5A	UF5D	UH6D
Saffron (rust)	UF5B	UF5E	UH6E
PRICING			
	sq. ft.	sq. ft.	pc
	\$3.10	\$3.30	\$5.52

WEIGHTS, QUANTITIES & DIMENSIONS

WEIGHTS			
Carton (lbs.)	50	63	21
Pallet (lbs.)	2400	2016	
QUANTITIES			
Tile per Carton	15	7	20
Cartons per Pallet	48	32	
DIMENSIONS			
One Carton (sq. ft.)	14.53	15.26	
One Pallet (sq. ft.)	697.44	488.32	

Sunnyvale, TX

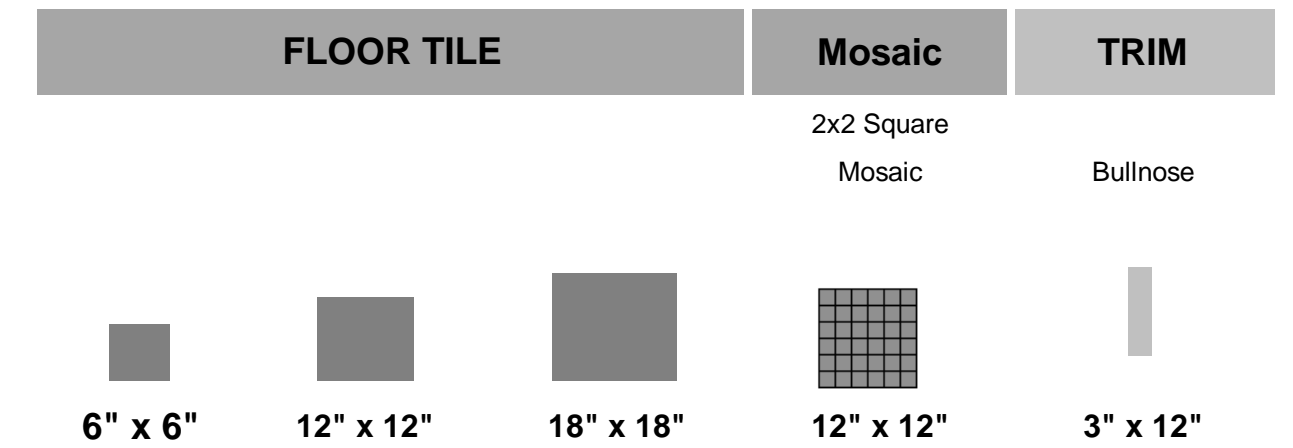

PRODUCTS, SIZES, CODES & PRICING

NAMES (colors)					
Lava River (Rust)	UL7U	UL7Y	UL84	ULCK	UL88
Lost Sea (Charcoal)	UL7V	UL7Z	UL85	ULCL	UL89
Mammoth (Brown)	UL7W	UL82	UL86	ULCM	UL8A
Sequoyah (Beige)	UL7X	UL83	UL87	ULCN	UL8B
PRICING					
	sq. ft.	sq. ft.	sq. ft.	pc	pc
	\$4.26	\$2.36	\$2.70	\$17.32	\$4.26

WEIGHTS, QUANTITIES & DIMENSIONS

WEIGHTS					
Carton (lbs.)	35	50	63	39	21
Pallet (lbs.)	2800	2400	2016	1755	
QUANTITIES					
Tile per Carton	40	15	7	10	20
Cartons per Pallet	80	48	32	45	
DIMENSIONS					
One Carton (sq. ft.)	9.69	14.53	15.26	9.69	
One Pallet (sq. ft.)	775.20	697.44	488.32	436.05	

Sunnyvale, TX

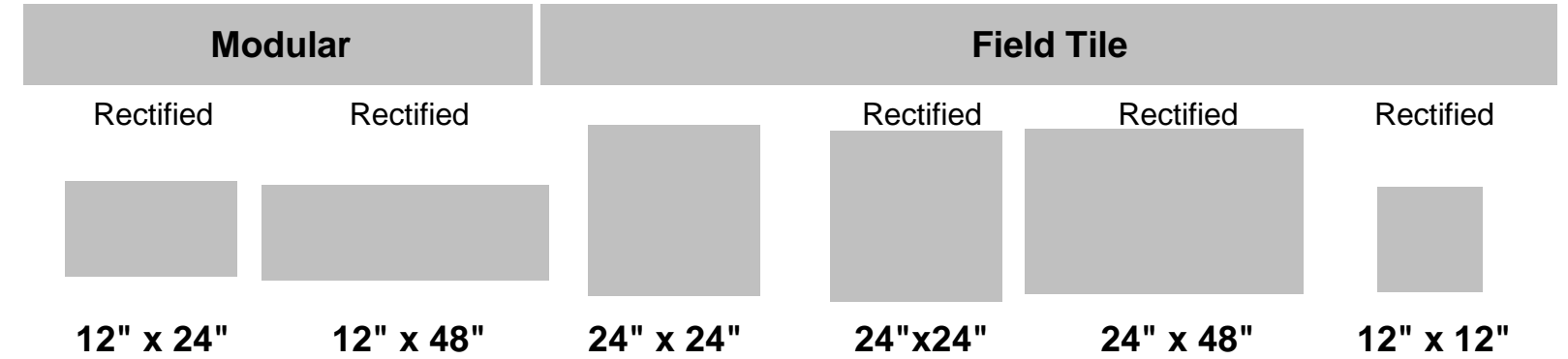

PRODUCTS, SIZES, CODES & PRICING

NAMES (colors)

Anthracite (dark blue)	MHSF N	M6ZH	MHHQ N	MHJM N	M6ZD	MHSP
Green	MHSG N	M6ZJ	MHHR N	MHJN N	M6ZE	MHSQ
Ivory	MHSD N	M6ZF	MHHN N	MHHT N	M6ZA	MHSM

PRICING

sq. ft.	sq.ft.	sq. ft.	sq.ft.	sq.ft.	sq. ft.
\$8.52	\$9.44	\$6.54	\$9.44	\$9.44	\$8.52

WEIGHTS, QUANTITIES & DIMENSIONS

WEIGHTS





Carton (lbs.)	50	61	61	60	80	56
Pallet (lbs.)	2400	1220	2440	2400	2400	2240

QUANTITIES

Tile per Carton	5	3	3	3	2	11
Cartons per Pallet	48	20	40	40	30	40

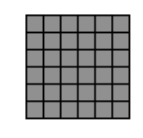
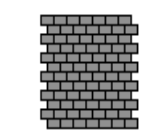
DIMENSIONS

One Carton (sq. ft.)	9.69	11.63	11.63	11.63	15.50	10.66
One Pallet (sq. ft.)	465.12	232.60	465.12	465.12	465	462.40

Mesh Mosaics		Listel	Trim			
2" x 2" Mesh Mounted	1-1/2" x 2-1/2" Mesh Mounted		Cove Base	Cove Base In Angle	Cove Base Out Angle	Single Bullnose
						
12" x 12"	12" x 12"	2" x 12"	6" x 12"	1" x 6"	1" x 6"	3" x 12"

PRODUCTS, SIZES, CODES & PRICING

NAMES (colors)

Anthracite (dark blue)	M54W N	M54R	MHT2	UHCD	UHCG	UHCK	UG4H
Green	M54X N	M54T	MHT3	UHCE	UHCH	UHCL	UG4J
Ivory	M54U N	M54P		UHCF	UHCJ	UHCM	UG4K

PRICING

pc	pc	pc	pc	pc	pc	pc	pc
\$22.64	\$22.64	\$25.94	\$14.98	\$11.44	\$11.44	\$11.44	\$6.16

WEIGHTS, QUANTITIES & DIMENSIONS

WEIGHTS

Carton (lbs.)	52	21	7	26	2	2	20
Pallet (lbs.)							

QUANTITIES

Tile per Carton	10	4	6	12	6	6	20
Cartons per Pallet							

DIMENSIONS

One Carton (sq. ft.)							
One Pallet (sq. ft.)							

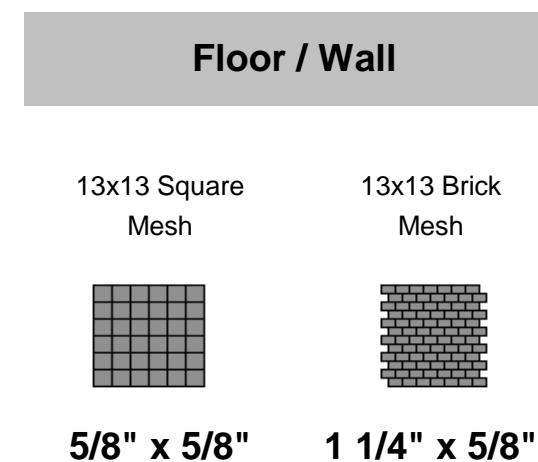

PRODUCTS, SIZES, CODES & PRICING

NAMES (colors)		
Flamenco (blue)	UJ98	UJAE
Jive (multi)	UJ99	UJAF
Samba (red)	UJ95	UJAB
Swing (white)	UJ97	UJAD
Tango (light green)	UJ94	UJAA
Waltz (dark green)	UJ96	UJAC





PRICING	sq. ft.	sq. ft.
	\$20.48	\$20.48

WEIGHTS, QUANTITIES & DIMENSIONS

WEIGHTS		
Carton (lbs.)	29	29
QUANTITIES		
Tile per Carton	10	10
DIMENSIONS		
One Carton (sq. ft.)	11.50	11.50

Studio M is non-stock / special order. Please allow 3 - 5 days for delivery.

Sunnyvale, TX

Modular	Field Tile		Mosaic	Trim
			2x2 Square Mosaic	Single Bullnose
				
6" x 6"	18" x 18"	12" x 12"	12" x 12"	3" x 12"

PRODUCTS, SIZES, CODES & PRICING

NAMES (colors)

Dumai (beige)	UG5T	UG5Z	UG5W	UG5W 2M	UG64
Giambi (gold)	UG5U	UG62	UG5X	UG5X 2M	UG65
Medan (noce)	UG5V	UG63	UG5Y	UG5Y 2M	UG67

PRICING

sq. ft.	sq. ft.	sq. ft.	pc	pc
\$4.26	\$2.60	\$2.28	\$9.64	\$4.26

WEIGHTS, QUANTITIES & DIMENSIONS

WEIGHTS

Carton (lbs.)	35	63	50	39	21
Pallet (lbs.)	2800	2016	2400		

QUANTITIES

Tile per Carton	40	7	15	10	20
Cartons per Pallet	80	32	48		

DIMENSIONS

One Carton (sq. ft.)	9.69	15.26	14.53		
One Pallet (sq. ft.)	775.20	488.32	697.44		

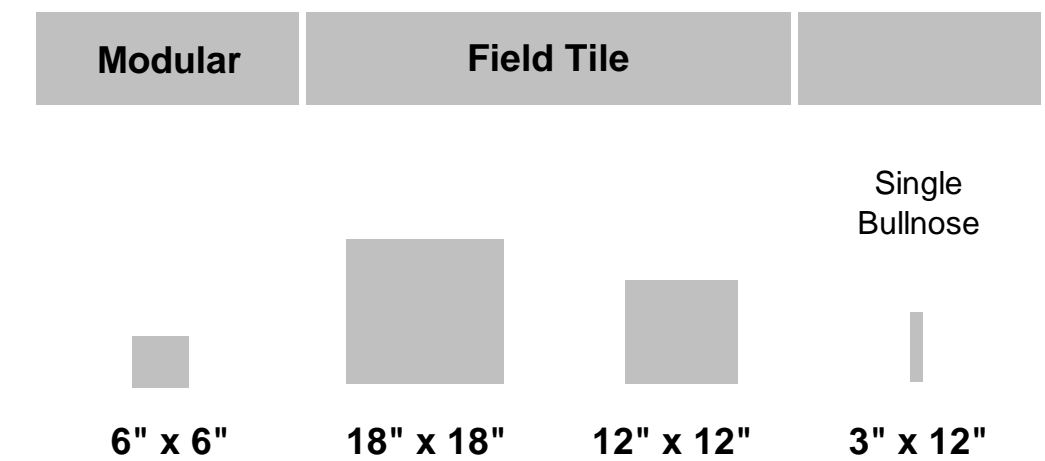

PRODUCTS, SIZES, CODES & PRICING

NAMES (colors)				
Desierto (brown)	UG2C	UG2G	UG2E	UG2S
Saguaro (yellow)	UG2B	UG2F	UG2D	UG2R

PRICING	sq. ft.	sq. ft.	sq. ft.	pc
	\$4.26	\$3.46	\$3.14	\$5.52

WEIGHTS, QUANTITIES & DIMENSIONS

WEIGHTS				
Carton (lbs.)	35	63	50	21
Pallet (lbs.)	2800	2016	2400	
QUANTITIES				
Tile per Carton	40	7	15	20
Cartons per Pallet	80	32	48	
DIMENSIONS				
One Carton (sq. ft.)	9.69	15.26	14.53	
One Pallet (sq. ft.)	775.20	488.32	697.44	

Field Tile



6" x 24"

PRODUCTS, SIZES, CODES & PRICING

NAMES (colors)	
Beige	AL7L
Black	AL7J
Brown	AL7K
Walnut	AL7M
PRICING	sq. ft.
	\$3.90

WEIGHTS, QUANTITIES & DIMENSIONS

WEIGHTS	
Carton (lbs.)	45
Pallet (lbs.)	2520
QUANTITIES	
Tile per Carton	10
Cartons per Pallet	56
DIMENSIONS	
One Carton (sq. ft.)	9.69
One Pallet (sq. ft.)	542.64

Florence, AL

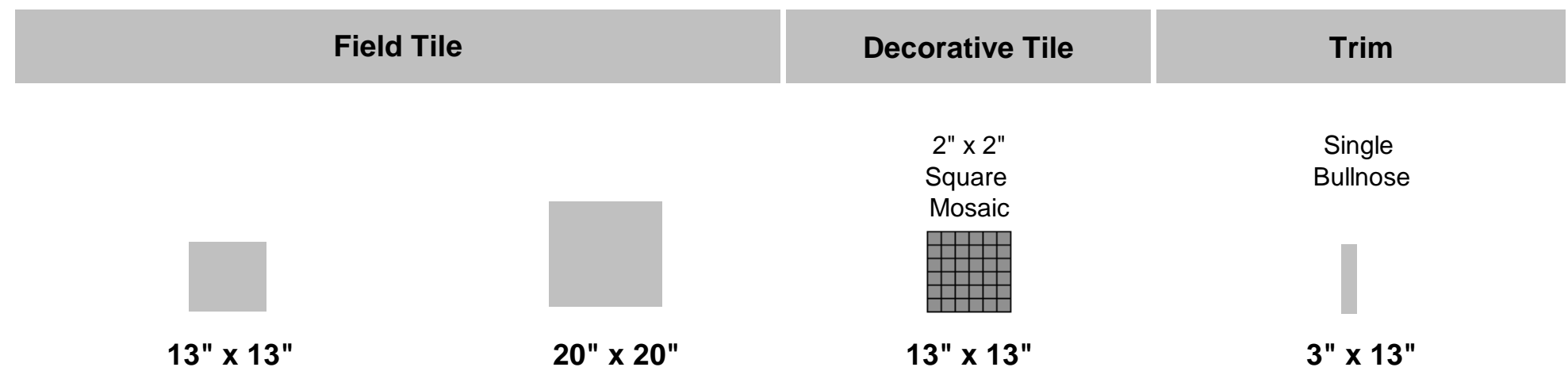

PRODUCTS, SIZES, CODES & PRICING

NAMES (colors)

Graphite (brown)	UH87	UH9A	UH9G	UH9D
Jasper (rust)	UH85	UH88	UH9E	UH9B
Midnight Black	UH86	UH89	UH9F	UH9C

PRICING

sq. ft.	sq. ft.	pc	pc
\$3.78	\$4.20	\$21.58	\$5.80

WEIGHTS, QUANTITIES & DIMENSIONS

WEIGHTS

Carton (lbs.)	73	79	39	21
Pallet (lbs.)	2774	1896		

QUANTITIES

Tile per Carton	15	6	10	20
Cartons per Pallet	38	24		

DIMENSIONS

One Carton (sq. ft.)	17.90	16.15	11.94	5.73
One Pallet (sq. ft.)	680.20	387.60		

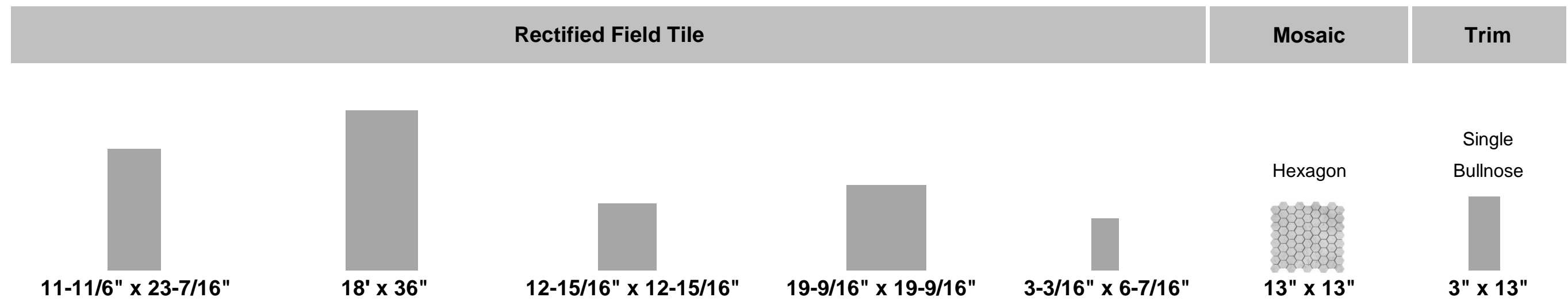

PRODUCTS, SIZES, CODES & PRICING

NAMES (colors)							
Calacatta Pearl (white)	UK2K	ULCP	UK2A	UK2D	UK2N	UK2V	UK2S
Emperador Mocha (brown)	UK2M	ULCR	UK2C	UK2F	UK2R	UK2X	UK2U
Marfil Cream (beige)	UK2L	ULCQ	UK2B	UK2E	UK2P	UK2W	UK2T
PRICING	sq. ft.	sq. ft.	sq. ft.	sq. ft.	sq. ft.	pc	pc
	\$5.96	\$7.38	\$5.36	\$5.68	\$5.96	\$31.34	\$5.84

WEIGHTS, QUANTITIES & DIMENSIONS

WEIGHTS							
Carton (lbs.)	50	63	58	79	42	39	21
Pallet (lbs.)	2000	2079	2204	1896	2142		
QUANTITIES							
Tile per Carton	5	3	15	6	72	10	20
Cartons per Pallet	40	33	38	24	51		
DIMENSIONS							
One Carton (sq. ft.)	9.51	12.90	17.43	15.96	10.22		
One Pallet (sq. ft.)	380.40	425.70	662.34	383.04	521.22		

Florence, AL

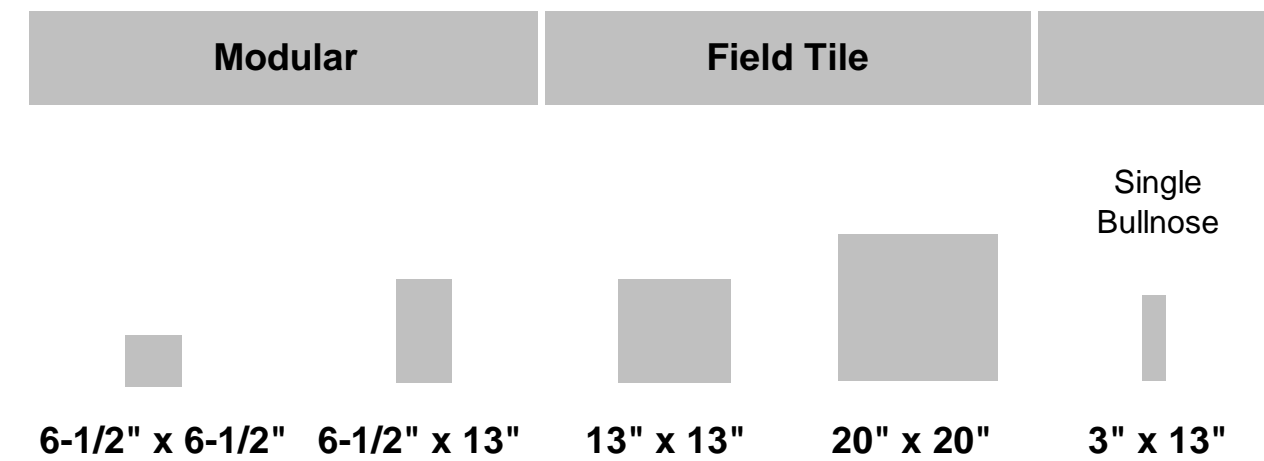

PRODUCTS, SIZES, CODES & PRICING

NAMES (colors)					
Amber	UB5D N2	UB5H N2	UB5M N	UB5V	UB6M
Beige	UB5E N2	UB5J N2	UB5N N	UB5W	UB6N
Ivory	UB5F N2	UB5K N2	UB5P N	UB5X	UB6P
Noce	UB5G N2	UB5L N2	UB5Q N	UB5Y	UB6Q
PRICING	sq. ft.	sq. ft.	sq. ft.	sq. ft.	pc
	\$5.14	\$5.14	\$3.78	\$4.20	\$5.36

WEIGHTS, QUANTITIES & DIMENSIONS

WEIGHTS					
Carton (lbs.)	42	42	73	79	18
Pallet (lbs.)	2142	2142	2774	1896	
QUANTITIES					
Tile per Carton	36	18	15	6	20
Cartons per Pallet	51	51	38	24	
DIMENSIONS					
One Carton (sq. ft.)	10.55	10.65	17.90	16.15	
One Pallet (sq. ft.)	538.05	543.15	680.20	387.60	



FLOOR TILE¹

Matte	Matte	Matte
6"x48" (15 x 120 cm)	8"x48" (20 x 120 cm)	12"x48" (30 x 120 cm)

PRODUCTS, SIZES, CODES & PRICING

NAMES (colors)

White	M7W1	M7WV	M7WN
Beige	M7W2	M7WW	M7WP
Capuccino	M7W3	M7WX	M7WQ
Teak	M7W4	M7WY	M7WR
Wenge	M7W5	M7WZ	M7WT
Black	M7W6	M7W0	M7WU

PRICING

	sq. ft.	sq. ft.	sq. ft.
	\$12.48	\$12.48	\$10.26

WEIGHTS, QUANTITIES & DIMENSIONS

WEIGHTS

Carton (lbs.)	58	38	59
Pallet (lbs.)	1276	1520	1180

QUANTITIES

Tile per Carton	6	3	3
Cartons per Pallet	22	40	20

DIMENSIONS

One Carton (sq. ft.)	11.630	7.750	11.630
One Pallet (sq. ft.)	255.86	310.00	232.60

SHADE VARIATION, APPLICATIONS & TECHNICAL FEATURES

¹Due to size fluctuation, all measurements given are nominal. Where strict accuracy is required, please refer to actual tile samples.



Modular Tile	Field Tile				Decorative Mosaics			Trim
6 1/2" x 6 1/2"	13" x 13"	10" x 20"	20" x 20"	1" x 1"	2" x 2"	2" x 3 1/2"	3" x 13"	

PRODUCTS, SIZES, CODES & PRICING

NAMES (colors)									
Moss (green)	UF2A N	UF2L N	UF2G	UF2Q	UF2Y	UF24	UF28	UF2U	
Rust (brown)	UF2B N	UF2M N	UF2H	UF2R	UF2Z	UF25	UF29	UF2V	
Sand (beige)	UF2C N	UF2N N	UF2J	UF2S	UF22	UF26	UF3A	UF2W	
Smoke (gray)	UF2D N	UF2P N	UF2K	UF2T	UF23	UF27	UF3B	UF2X	
PRICING	sq. ft.	sq. ft.	sq. ft.	sq. ft.	pc	pc	pc	pc	
	\$4.52	\$3.78	\$4.42	\$4.20	\$35.70	\$23.10	\$33.60	\$5.36	

WEIGHTS, QUANTITIES & DIMENSIONS

WEIGHTS									
Carton (lbs.)	42	73	64	79	33	39	45	22	
Pallet (lbs.)	2142	2774	1792	1896					
QUANTITIES									
Tile per Carton	36	15	10	6	10	10	10	20	
Cartons per Pallet	51	38	28	24					
DIMENSIONS									
One Carton (sq. ft.)	10.55	17.90	13.46	16.15					
One Pallet (sq. ft.)	538.05	680.20	376.88	387.60					

Field Tile			Trim						Decos			Mosaics	
6.5"x6.5"	13"x13"	20"x20"	Single Bullnose	Cove Base In Angle	Cove Base Out Angle	Cove Base	Pencil Liner	Chair Rail	Floral Insert	Floral Insert	Floral Insert	Square Mosaic	Brick Mosaic
6.5"x6.5"	13"x13"	20"x20"	3"x13"	1" x 6"	1" x 6"	6"x13"	1/2" x 13"	1.5" x 13"	1" x 1"	2"x 2"	4" x 4"	2"x2"	2"x4"

PRODUCTS, SIZES, CODES & PRICING

NAMES (colors)

Golden	UHDQ	UHC3	UHC6	UHDW	UJ2B	UJ2E	UHDZ						UHD4	UHD7
Multi	UHDR	UHC4	UHC7	UHDX	UJ2C	UJ2F	UHD2						UHD5	UHD8
Cream	UJ3W	UJ3U	UJ3V	UJ3Y	UJ32	UJ33	UJ3Z						UJ34	UJ35
Umber	UHDP	UHC2	UHC5	UHDV	UJ2A	UJ2D	UHDY						UHD3	UHD6
Romance Bronze								UJ6R	UJ6P	UJ6Z	UJ6X	UJ6V		
Romance Nickel								UJ6Q	UJ6N	UJ6Y	UJ6W	UJ6U		

PRICING	sq. ft.	sq. ft.	sq. ft.	pc	pc	pc	pc	pc	pc	pc	pc	pc	pc	pc
	\$5.36	\$3.78	\$4.20	\$5.80	\$11.44	\$11.44	\$15.00	\$12.44	\$15.60	\$3.62	\$4.76	\$13.08	\$20.20	\$29.86

WEIGHTS, QUANTITIES & DIMENSIONS

WEIGHTS









Carton (lbs.)	42	73	79	21	2	2	42	3	8	1	1	7	39	45
Pallet (lbs.)	2142	2774	1896											

QUANTITIES

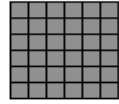
Tile per Carton	36	15	6	20	6	6	12	10	10	10	8	8	10	10
Cartons per Pallet	51	38	24											

DIMENSIONS

One Carton (sq. ft.)	10.55	17.90	16.15											
One Pallet (sq. ft.)	538.05	680.20	387.60											

Modular	Field Tile		Mosaic	Trim						
										
6 1/2" x 6 1/2"	13" x 13"	20" x 20"	2" x 2" Mesh Mounted 13" x 13"	6" x 8"	1" x 6"	1" x 6"	2-3/8" x 6-1/2"	7/8" x 2-3/8"	3" x 13"	

PRODUCTS, SIZES, CODES & PRICING

NAMES (colors)										
Canyon City (beige)	A402 N	A397 N	A392	AE3K	AH35	AH39	AH4D	AF4C	AF4G	AE33 N
Yukon Trail (noce)	A403 N	A398 N	A393	AE3N	AH36	AH4A	AH4E	AF4F	AF4K	AE34 N
Gold Rush (gold)	A404 N	A399 N	A394	AE3M	AH37	AH4B	AH4F	AF4D	AF4H	AE35 N
Klondike (red)	AF2Q N	AF2R N	AF2S	AF2U	AH38	AH4C	AH4G	AF4E	AF4J	AF2T N
PRICING	sq. ft.	sq. ft.	sq. ft.	sq. ft.	pc	pc	pc	pc	pc	pc
	\$4.84	\$3.78	\$4.20	\$24.16	\$7.88	\$12.48	\$12.48	\$12.60	\$18.90	\$4.74

WEIGHTS, QUANTITIES & DIMENSIONS

WEIGHTS										
Carton (lbs.)	42	62	79	39	26	2	2	3	1	23
Pallet (lbs.)	2142	2728	1896	1755						
QUANTITIES										
Tile per Carton	36	13	6	10	24	6	6	10	4	20
Cartons per Pallet	51	44	24	45						
DIMENSIONS										
One Carton (sq. ft.)	10.55	15.52	16.15	11.94						
One Pallet (sq. ft.)	538.05	682.88	387.60	536.85						

Florence, AL

SKU	SIZE	SF / CT	PC / CT	LBS / CT	PRICE
-----	------	---------	---------	----------	-------

PRODUCTS, SIZES, CODES & PRICING

NAMES (colors)						
Alabama Travertine Brushed / Straight Edge	8x8, 8x16, 16x16, 16x24	208B AMT	VERSAI	16 sf/set	2 ea/set	88 lbs/set \$ 10.82
Alabama Travertine Brushed / Chiseled Edge	8x8, 8x16, 16x16, 16x24	208C AMT	VERSAI	16 sf/set	2 ea/set	88 lbs/set \$ 10.82
Alabama Travertine Brushed / Straight Edge		207B AMT	18x18	2.25	1	13.75 \$ 8.52
Alabama Travertine Brushed / Chiseled Edge		302C AMT	8x8	0.45	1	3.34 \$ 10.24
Alabama Travertine Tumbled		303 4L	4x4	5	45	22 \$ 11.46
Alabama Travertine Tumbled		303 6L	6x6	5	20	22 \$ 12.88
Alabama Travertine Tumbled		303 1M	1x1	10	10	41.5 \$ 14.62
Alabama Travertine Mesh Mosaic Tumbled		303 2M	2x2	10	10	41.5 \$ 18.38
Alabama Travertine Polished / Straight Edge		303 2MS	2x2	10	10	41.5 \$ 13.24
Alabama Cornice Molding		303 CR134	1-3/4x12		30	39 \$ 9.46
Alabama Rail Molding		303 CR238	2-3/8x12		1	1.88 \$ 9.46
Alabama Bar Liner		303 CR34	3/4x12		1	0.6 \$ 6.30
Antique Travertine Select Honed / Filled		335H AMT	18x18	2.25	1	13.75 \$ 10.72
Antique Travertine Honed / Filled		371H AMT	12x12	1	1	5.50 \$ 6.20
Antique Travertine Honed / Filled		370H AMT	18x18	2.25	1	13.75 \$ 7.72
Antique Tuscany Brushed / Straight Edge		765 AMT	18x18	2.25	1	13.75 \$ 3.92
Chiaro Tumbled		490 4L	4x4	5	45	24.50 \$ 8.58
Chiaro Tumbled		490 6L	6x6	5	20	26.20 \$ 9.36
Chiaro Tumbled		490 36L	3x6	5	40	22.36 \$ 6.62
Chiaro Split Face		490 12M	1x2	1	1	4.15 \$ 16.38
Chiaro Mesh Mosaic		490 58M	5/8x5/8	10	10	41.5 \$ 17.12
Chiaro Mesh Mosaic		490 1M	1x1	10	10	41.5 \$ 11.66
Chiaro Mesh Mosaic		490 2M	2x2	10	10	41.5 \$ 10.72
Chiaro Mesh / Straight Edge		490 2MS	2x2	10	10	41.5 \$ 11.50
Chiaro Brick Mesh Tumbled		490 12B	1x2	1	1	4.15 \$ 11.66
Chiaro Tumbled Diamond		490 DIAMOND	4"	2.37	30	10.80 \$ 12.60
Chiaro Cornice Molding		490 CR134	1-3/4x12		30	30 \$ 9.46
Chiaro Rail Molding		490 CR238	2-3/8x12		1	1.55 \$ 9.46
Chiaro Bar Liner		490 CR34	3/4x12		1	0.66 \$ 6.30

SKU	SIZE	SF / CT	PC / CT	LBS / CT	PRICE
-----	------	---------	---------	----------	-------

PRODUCTS, SIZES, CODES & PRICING

NAMES (colors)						
Golden Travertine Tumbled	102 AMT	12x12	10	10	58.79	\$ 11.12
Golden Travertine	102 4L	4x4	5	45	24.50	\$ 7.84
Golden Travertine	102 6L	6x6	5	20	26.20	\$ 8.92
Golden Travertine Mesh	102 58M	5/8x5/8	10	10	41.50	\$ 18.34
Golden Travertine Mesh	102 2M	2x2	10	10	41.50	\$ 12.90
Golden Travertine Cornice Molding	102 CR134	1-3/4x12		30	30	\$ 7.66
Golden Travertine Rail Molding	102 CR238	2-3/4x12		1	1.55	\$ 8.78
Golden Travertine Bar Liner	102 CR34	3/4x12		1	0.66	\$ 5.10
Golden Travertine Select	204 AMT	18x18	2.25	1	13.75	\$ 8.36
Ivory Classic Honed/Filled Straight	125H AMT	18x18	2.25sqft/pc	160pc/pa	2203lbs./pa	\$ 7.72
Ivory Classic Honed/Filled Straight	143H AMT	12x12	1sqft/pc		5lbs./pc	\$ 6.20
Light Tuscany Travertine Honed / Filled	732H AMT	18x18	2.25	1	13.75	\$ 8.40
Noce Brushed / Hammered Edge	347 AMT	VERSAI	16 sf/set	2 ea/set	100 lbs/set	\$ 11.56
Noce Brushed / Hammered Edge	346 AMT	18x18	2.25	1	13.75	\$ 11.98
Noce Brushed / Hammered Edge	350 AMT	16x24	2.67	1	13.94	\$ 11.56
Noce Brushed / Hammered Edge	349 AMT	8x16	0.89	1	6.97	\$ 11.56
Noce Brushed / Hammered Edge	348 AMT	8x8	0.45	1	3.49	\$ 11.56
Noce Tumbled	491 4L	4x4	5	45	24.50	\$ 8.58
Noce Tumbled	491 6L	6x6	5	20	26.20	\$ 9.36
Noce Tumbled	491 36L	3x6	5	40	22.36	\$ 6.94
Noce Mesh Mosaic	491 58M	5/8x5/8	10	10	41.50	\$ 22.06
Noce Mesh Mosaic	491 1M	1x1	10	10	41.50	\$ 11.50
Noce Mesh Mosaic	491 2M	2x2	10	10	39	\$ 15.54
Noce Mesh Split Face	491 12M	1x2	1	1	4.15	\$ 16.38
Noce Diamond	491 DIAMOND	4"	2.37	30	20.20	\$ 12.60
Noce Cronice Molding	491 CR134	1-3/4x12		30	30	\$ 9.46
Noce Rail Molding	491 CR238	2-3/8x12		1	1.55	\$ 9.46
Noce Bar Liner	491 CR34	3/4x12		1	0.66	\$ 9.46

SKU	SIZE	SF / CT	PC / CT	LBS / CT	PRICE
-----	------	---------	---------	----------	-------

PRODUCTS, SIZES, CODES & PRICING

NAMES (colors)						
Roman Blend Honed / Chiseled	379C AMT	8x8	0.45	1	3.34	\$ 8.82
Roman Blend Honed / Chiseled	380C AMT	8x16	0.89	1	5.31	\$ 8.82
Roman Blend Honed / Chiseled	376H AMT	18x18	2.25	1	13.77	\$ 8.82
Roman Blend Honed / Chiseled 8x8, 8x16, 16x16, 16x24	375C AMT	VERSAI	16/st	12/st	98/st	\$ 8.82
Roman Blend Mini Diamond Mesh	374 MD	3-1/2"	10	10	41.5	\$ 18.12
Roman Blend Mini Versai Mesh	374 MV		10	10	41.5	\$ 18.12
Roman Blend Mesh Brick Tumbled	374 12B	1x2	4.15	1	4.15	\$ 16.86
Romen Blend Mesh Tumbled	374 2M	2x2	10	10	41.5	\$ 13.54
Roman Blend Tumbled	374 58M	5/8x5/8	10	10	41.5	\$ 17.02
Roman Blend Tumbled	374 36L	3x6	5	40	22.36	\$ 7.26
Roman Blend Tumbled	374 4L	4x4	5	45	22	\$ 7.26

SKU	SIZE	SF / CT	PC / CT	LBS / CT	PRICE
-----	------	---------	---------	----------	-------

PRODUCTS, SIZES, CODES & PRICING

NAMES (colors)					
Scabas Cornice	352 CR134	1-3/4x12		30	38.85 \$ 7.88
Scabas Rail Molding	352 CR238	2-3/8x12		1	1.55 \$ 8.68
Scabas Bar Liner	352 CR34	3/4x12		1	0.63 \$ 6.46
Scabas Diamond Tumbled	352 DIAMOND	4"	2	30	10.8 \$ 1.54
Scabas Tumbled Mesh	352 1M	1x1	10	10	41.5 \$ 15.44
Scabas Mesh Brick Tumbled	352 12B	1x2	10	10	41.5 \$ 11.82
Scabas Tumbled Mesh Split Face	352 12M	1x2	10	10	41.5 \$ 16.18
Scabas Mesh Tumbled	352 2M	2x2	10	10	41.5 \$ 18.54
Scabas Mesh / Straight Edge	352 2MS	2x2	10	10	41.5 \$ 13.08
Scabas Tumbled	352 36L	3x6	5	40	22.36 \$ 7.26
Scabas Tumbled	352 4L	4x4	5	45	22 \$ 9.02
Scabas Tumbled	352 58M	5/8x5/8	10	10	41.5 \$ 16.06
Scabas Tumbled	352 6L	6x6	5	22	22 \$ 9.58
Scabas Honed, Filled & Straight Edge	352H AMT	12x12	1		5.5 \$ 7.98
Scabas Honed & Brushed Chiseled Edge	353C AMT	VERSI	16/st	12/st	98/st \$ 7.98
Scabas Honed/Filled Straight Edge	368H AMT	18x18	2.25/pc	160/pa	2203/pa \$ 8.68
Scabas Brushed Straight Edge	353B AMT	VERSI	16/st	12/st	98/lb \$ 7.98

SKU	SIZE	SF / CT	PC / CT	LBS / CT	PRICE
-----	------	---------	---------	----------	-------

PRODUCTS, SIZES, CODES & PRICING

NAMES (colors)						
Saint Adrian Polished	743 AMM	12x12	10	10	58.79	\$ 9.78
Saint Adrian Polished	742 AMM	18x18	2.25	1	13.57	\$ 11.04
Saint Adrian Polished Mesh	743 1M	1x1	10	10	44.75	\$ 14.02
Saint Adrian Polished Mesh	743 2M	2x2	10	10	41.5	\$ 13.40
Saint Adrian Polished Cornice Molding	743 CR134	1-3/4x12		30	30	\$ 12.60
Saint Adrian Polished Bar Liner	743 CR34	3/4x12		1	0.66	\$ 11.04
Saint Adrian Polished Rail Molding	743 CR238	2-3/8x12		1	1.55	\$ 14.50
Walnut Travertine Versai Pattern Brushed / Chiseled Edge	222 AMT	Versai	16 / set	12 / set	98 / set	\$ 10.88
Walnut Travertine Brushed / Hammered Edge	221 AMT	18x18	2.25	1	13.75	\$ 8.52
Walnut Travertine Brushed / Hammered Edge	345 AMT	16x24	2.67	1	13.94	\$ 10.50
Walnut Travertine Brushed / Hammered Edge	344 AMT	8x16	0.89	1	6.97	\$ 10.50
Walnut Travertine Brushed / Hammered Edge	343 AMT	8x8	0.45	1	3.49	\$ 10.50
ACCESSORIES						
Cream Shampoo Shelf	CR LSHELF	LARGE		6	31.98	\$ 41.74
Cream Soap Dish	CR SOAPDISH			10	3	\$ 23.10
Cream Towel Bar 3 pc/set	CR TOWELBAR			10 set/ct	2.70	\$ 23.10
Medium Shampoo Shelf	MD LSHELF	LARGE		6	31.98	\$ 41.74
Medium Soap Dish	MD SOAPDISH			6	31.98	\$ 23.10
Medium Towel Bar 3 pc/set	MD TOWELBAR			10 set/ct	2.70	\$ 23.10
Noce Shampoo Shelf	NOCE LSHELF	LARGE		6	31.98	\$ 41.74
Noce Soap Dish	NOCE SOAPDISH			10	3	\$ 23.10
Noce Towel Bar 3 pc/set	NOCE TOWELBAR			10 set/ct	2.70	\$ 23.10

Chiseled			Honed						
						Straight Edge	Straight Edge	Straight Edge	Straight Edge
3" x 6"	4" x 4"	6" x 6"	1" x 1"	2" x 2"	3" x 6"	4" x 2"	4" x 4"	4" x 8"	6" x 6"

PRODUCTS, SIZES, CODES & PRICING

NAMES (colors)										
Tabacco				363 1H	363 2H	363 36H	363 42H	363 4H	363 48H	363 6H
Romani				364 1H	364 2H	364 36H	364 42H	364 4H	364 48H	364 6H
Desert Cream	388 36C	388 4C	388 6C							
PRICING	sq.ft.	sq.ft.	sq.ft.	sq.ft.	sq.ft.	sq.ft.	sq.ft.	sq.ft.	sq.ft.	sq.ft.
	\$8.20	\$6.62	\$6.62	\$14.96	\$12.76	\$8.98	\$11.82	\$8.04	\$8.98	\$8.04

WEIGHTS, QUANTITIES

WEIGHTS										
Carton (lbs.)	56	56	56	55	55.5	56	55.5	56	56	56
QUANTITIES										
Tile per CT	80	90	40	10	10	80	10	90	45	40
DIMENSIONS										
One CT sq.ft.	10	10	10	10	10	10	10	10	10	10

Mesh Mounts											
Blended Square	Blended Square	Blended Mini	Split Face	Split Face	Split Face	Split Face	Brick	Mini	Square	Square	Square
1" x 1"	5/8" x 5/8"	Diamond	1" x 2"	3" x 6"	4" x 8"	6" x 24"	4" x 2"	Diamond	1" x 1"	2" x 2"	5/8" x 5/8"

PRODUCTS, SIZES, CODES & PRICING

NAMES (colors)

Blended (Amber, Durango, Noce, Sienna)	BLEN 11	BLEN 58	BLEN MD									
Durango				358 12M	358 36M	358 48M	358 624M	358 42M	358 MD	358 1M	358 2M	358 58M
Noce				360 12M	360 36M	360 48M	360 624M	360 42M	360 MD	360 1M	360 2M	360 58M
Sienna				362 12M	362 36M	362 48M		362 42M	362 MD	362 1M	362 2M	362 58M
Tabacco					363 36M							
Romani					364 36M							
Desert Cream								388 42M		388 1M	388 2M	388 58M

PRICING	pc	pc	pc	sq.ft.	sq.ft.	sq.ft.	sq.ft.	sq.ft.	sq.ft.	sq.ft.	sq.ft.	sq.ft.
	\$15.66	\$26.36	\$15.66	\$19.58	\$13.08	\$14.64	\$17.02	\$9.06	\$12.52	\$14.12	\$12.22	\$24.26

WEIGHTS, QUANTITIES

WEIGHTS

Carton (lbs.)	56	56	56	36.6	15	14	55	55	55	55	55	55
----------------------	----	----	----	------	----	----	----	----	----	----	----	----

QUANTITIES

Tile per CT	10	10	10	6	2.5	2.44	10	10	10	10	10	10
--------------------	----	----	----	---	-----	------	----	----	----	----	----	----

DIMENSIONS

One CT sq.ft.	10	10	10	6	20	11	10	10	10	10	10	10
----------------------	----	----	----	---	----	----	----	----	----	----	----	----

Wide Bevel			Plank				Honed/Filled Cross Cut				
3" x 6"	4" x 4"	6" x 6"	6" x 16"	8" x 16"	10" x 32"	8" x 16"	12" x 12"	16" x 16"	12" x 24"	18" x 18"	

PRODUCTS, SIZES, CODES & PRICING

NAMES (colors)											
Durango	358 36WB	358 4WB	358 6WB					358H AMT			357H AMT
Noce	360 36WB	360 4WB	360 6WB					360H AMT			359H AMT
Sienna	362 36WB	362 4WB	362 6WB					362H AMT			361H AMT
Tabacco				363 616	363 824	363 1032	363 816	363H AMT	363B AMT	363C AMT	
Romani				364 616	364 824	364 1032	364 816	364H AMT	364B AMT	364C AMT	
Desert Cream								388H AMT	388B AMT		
PRICING	sq.ft.	sq.ft.	sq.ft.	sq.ft.	sq.ft.	sq.ft.	sq.ft.	sq.ft.	sq.ft.	sq.ft.	sq.ft.
	\$10.50	\$11.34	\$9.86	\$10.08	\$10.08	\$10.08	\$8.06	\$7.40	\$8.06	\$9.76	\$8.46

WEIGHTS, QUANTITIES

WEIGHTS											
Carton (lbs.)	56	56	56	59	59	61.5	59.5	55.5	59.5	11.08	12.47
QUANTITIES											
Tile per CT	80	90	40	16	8	5	12	10	6	1	1
DIMENSIONS											
One CT sq.ft.	10	10	10	10.66	10.66	11.11	10.68	10	10.68	2	1

Tumbled				Straight Edge	Chiseled Edge	Nano	Micro	Mini
Brick	Diamond	Square	Square	Honed/Filled	Honed/Filled	Tumbled 5/8"	Tumbled 1"	Tumbled 2"
3" x 6"	3" x 6"	4" x 4"	6" x 6"	Versai	Versai	Versai	Versai	Versai

PRODUCTS, SIZES, CODES & PRICING

NAMES (colors)									
Durango	358 36L	358 36LD	358 4L	358 6L	358H V		358 NANO V	358 MCV	358 MV
Noce	360 36L	360 36LD	360 4L	360 6L			360 NANO V	360 MICRO V	360 MV
Sienna	362 36L	362 36LD	362 4L	362 6L	362H V		362 NANO V	362 MICRO V	362 MV
Tabacco			363 4L	363 6L				363 V	
Romani			364 4L	364 6L				364 V	
Desert Cream	388 36L		388 4L	388 6L					
PRICING	sq.ft.	sq.ft.	sq.ft.	sq.ft.	sq.ft.	sq.ft.	sq.ft.	sq.ft.	sq.ft.
	\$8.46	\$9.94	\$8.04	\$8.04	\$9.46	\$10.08	\$25.68	\$22.20	\$15.70

WEIGHTS, QUANTITIES

WEIGHTS									
Carton (lbs.)	56	56	56	56	43.47/set	88.83	55.5	56	56
QUANTITIES									
Tile per CT	80	90	90	40	12/set	12/set	10	10	10
DIMENSIONS									
One CT sq.ft.	10	10	10	10	16/set	16/set	10	10	10

Liners

Coral Liner	Corinza Liner	Chair Rail	Trevol	Pencil Liner	Rope Liner
3" x 12"	2-1/2" x 12"	2" x 12"	3" x 12"	3/4" x 12"	1-1/4" x 12"

PRODUCTS, SIZES, CODES & PRICING

NAMES (colors)						
Durango	358 CORAL	358 CORNIZA	358 CRAIL		358 PENCIL	358 ROPE
Noce	360 CORAL	360 CORNIZA	360 CRAIL		360 PENCIL	360 ROPE
Sienna	362 CORAL	362 CORNIZA	362 CRAIL		362 PENCIL	362 ROPE
Tabacco				363 TREVOL	363 PENCIL	
Romani				364 TREVOL	364 PENCIL	
Desert Cream		388 CORNIZA	388 CRAIL		388 PENCIL	

PRICING	pc	pc	pc	pc	pc	pc
	\$12.22	\$12.92	\$13.40	\$21.26	\$8.82	\$13.92

WEIGHTS, QUANTITIES

WEIGHTS						
Carton (lbs.)	35.32	47.30	52	35	40.50	40.50
QUANTITIES						
Tile per CT	26	22	26	12	75	30

SKU	SIZE	LBS/CT	PC/CT	PRICE
-----	------	--------	-------	-------

PRODUCTS, SIZES, CODES & PRICING

NAMES (colors)				
Antibe	ANTI LISTEL	2x12	46.8	50 \$ 14.60
Barabara	BARB BORDER	5-1/2x12	47	30 \$ 48.58
Bubble Border	BUBL BORDER	6x13	47	10 \$ 44.10
Bubble Mosaic	BUBL MOSAIC	12x12	55	10 \$ 75.60
Byzantine	BYZ BORDER	4-1/2x12	46.8	30 \$ 57.02
Candace	CAND LISTEL	6x12	55	20 \$ 15.76
Caramelo	CARM LISTEL	6x12	25	8 \$ 56.70
Colonial Brick	CB LISTEL	4x12	46.8	30 \$ 9.78
Emma	EMMA LISTEL	4-1/2x12	46.8	30 \$ 17.32
Idaly	IDAL LISTEL	6x16	20	5 \$ 94.50
Iglesia	IGL LISTEL	6-3/4x14-3/4	46.8	30 \$ 47.42
Irma	IRMA LISTEL	5x12	20	8 \$ 47.25
Josie	JOSI LISTEL	6x12	55	20 \$ 17.64
Lorenzo	LORE LISTEL	4x12	30	16 \$ 44.10
Luisa	LUIS LISTEL	4-3/8x11-3/8	20	10 \$ 17.64
Madrid	MADR LISTEL	2-3/4x12	46.8	50 \$ 13.12
Maria	MARI BORDER	4-1/2x12	47	30 \$ 57.76
Nocce Star	NS LISTEL	4-1/2x12	46.8	30 \$ 15.96
Naibory	NAIB LISTEL	4-3/4x12-1/4	46.8	30 \$ 17.80
Normandy	NORM LISTEL	6x12	46.8	20 \$ 48.58
Orsay	ORSY BORDER	7-1/2x12	55	10 \$ 43.80
Patricia	PAT LISTEL	5x12	43.68	28 \$ 44.38
River Rock	MC RRIM18	18x18	61.875	5 \$ 22.74
River Rock White	WHT RRIM18	18x18	62.4	5 \$ 22.74
Romance	ROMA BORDER	6x11-1/2	25	8 \$ 96.60
Rosetta	ROSE LISTEL	4-5/8x11-3/8	46.8	30 \$ 15.44
Sarah	SARA LISTEL	5x12	46.8	30 \$ 25.72
Silveta	SILV LISTEL	6x12	25	8 \$ 56.70
Victorina	VICT LISTEL	3-7/8x12	46.8	30 \$ 15.44

SKU	SIZE	SF / CT	PC / CT	LBS / CT	PRICE
-----	------	---------	---------	----------	-------

PRODUCTS, SIZES, CODES & PRICING

NAMES (colors)						
Beehive Mosaic	630 AMS	1x1	10	10	57.55	\$ 15.54
California Gold Gauged	576 AMS	12x12	10	10	53	\$ 4.46
California Gold Gauged	600 AMS	16x16	10.68	6	64.10	\$ 7.10
California Gold Tumbled	637 AMS	4x4	5.56	50	32.22	\$ 6.72
California Gold Tumbled	636 AMS	3x6	6.25	50	36	\$ 6.72
California Gold Honed Mosaic	638 AMS	1x1	10	10	57.55	\$ 18.48
Copper Quartzite Gauged	523 AMS	12x12	1	1	5	\$ 4.56
Copper Quartzite Gauged	510 AMS	16x16	14.22	8	85.32	\$ 5.64
Copper Quartzite Honed Mosaic	633 AMS	1x1	10	10	57.55	\$ 18.48
Green Mica Honed	631 AMS	12x12	10	10	53.57	\$ 11.34
Green Mica Honed Mosaic	632 AMS	1x1	10	10	57.55	\$ 18.48
Indian Autumn Gauged	478 AMS	12x12	10	10	53	\$ 5.24
Indian Autumn Gauged	585 AMS	16x16	10.68	6	64.10	\$ 5.66
Indian Autumn Tumbled	628 AMS	4x4	5.56	50	32.22	\$ 6.72
Indian Autumn Tumbled	627 AMS	3x6	6.25	50	36	\$ 6.72
Indian Autumn Honed Mosaic	629 AMS	1x1	10	10	57.55	\$ 18.48
Indian Autumn 1 CT / SET	626 AMS	Versai	15.93	12	103	\$ 6.58
Indian Autumn 2 CT / SET	626 AMS-2	Versai	15.93	12	89.32	\$ 6.58
Multicolor Gauged	517 AMS	12x12	10	10	51.60	\$ 3.16
Multicolor Gauged	533 AMS	16x16	17.8	10	90	\$ 4.66
Multicolor Tumbled	491 AMS	4x4	5.56	50	32.22	\$ 5.68
Multicolor Tumbled	634 AMS	3x6	6.25	50	36	\$ 6.72
Multicolor Honed Mosaic	635 AMS	1x1	10	10	57.55	\$ 18.48
Multicolor 1 CT / SET	555 AMS	Versai	15.93	12	103	\$ 4.82

SKU	SIZE	PC / CT	LB / CT	Price
-----	------	---------	---------	-------

PRODUCTS, SIZES, CODES & PRICING

NAMES (colors)

EBB

Drain Body & Plug 4" sq.	4400 E	4"	24	26.29	\$ 8.68
--------------------------	--------	----	----	-------	---------

Adaptor	E203		21	23	\$ 9.70
---------	------	--	----	----	---------

Grate Drain Covers

Polished Chrome	4401 E	4"	12	13.15	\$ 17.34
-----------------	--------	----	----	-------	----------

Bright Brass	4402 E	4"	12	13.15	\$ 17.34
--------------	--------	----	----	-------	----------

Black Chrome	4403 E	4"	12	13.15	\$ 17.34
--------------	--------	----	----	-------	----------

Brushed Nickel	4404 E	4"	12	13.15	\$ 17.34
----------------	--------	----	----	-------	----------

Antique Pewter	4405 E	4"	12	13.15	\$ 17.34
----------------	--------	----	----	-------	----------

Polished Copper	4406 E	4"	12	13.15	\$ 17.34
-----------------	--------	----	----	-------	----------

Oil Rubbed Bronze	4407 E	4"	12	13.15	\$ 17.34
-------------------	--------	----	----	-------	----------

Brushed Bronze	4408 E	4"	12	13.15	\$ 17.34
----------------	--------	----	----	-------	----------

Polished Nickel	4409 E	4"	12	13.15	\$ 17.34
-----------------	--------	----	----	-------	----------

Satin Nickel	4410 E	4"	12	13.15	\$ 17.34
--------------	--------	----	----	-------	----------

>> **Please note:** the standard discount does not apply to Ebbe products. The prices listed here are the sale price.

SKU	Package	PC / PLT	LBS / PLT	PRICE
-----	---------	----------	-----------	-------

PRODUCTS, SIZES, CODES & PRICING

NAMES (colors)				
•Self Leveling / Patching				
NXT Embossing Admix	WHT NXTEA5	5 quart	28	322 \$ 78.68
NXT Primer	WHT NXTPGAL	1 Gal.	48	456 \$ 101.32
NXT Primer	WHT NXTP5GAL	5 Gal.	48	2016 \$ 428.50
NXT Primer	WHT NXTP245	245 Gal.	1	2200 \$ 14,335.90
NXT Level	GRAY NXTL50	50 lb.	48	2400 \$ 41.62
NXT Level Plus	GRAY NXTLP55	55 lb.	40	2200 \$ 66.52
NXT Patch	GRAY NXTP25	25 lb.	64	1600 \$ 33.60
NXT Skim	GRAY NXTSK10	10 lb.	52	520 \$ 34.18
•Anti-Fracture / Crack Suppression				
Blue 92 Anti-Fracture Crack Isolation Kit	92 CSK	KIT	45	1175 \$ 280.32
Blue 92 Anti-Fracture Membrane	92 FULL	Full Unit	36st/pa	2246 \$ 883.98
125 Sound & Crack Adhesive	125 25	25 lb. Bag	56	1400 \$ 200.78
Strata Mat Uncoupling Membrane 323 sf/roll	STRATA323	45" x 86'	6	246 \$ 620.98
Strata mat Uncoupling Membrane 150 sf/roll	STRATA150	45" x 40'	12	228 \$ 282.48
•Miscellaneous				
3701 Fortified Mortar Bed	3701 60	60 lb. Bag	56	3466 \$ 51.98
3701 Fortified Mortar Bed Super Sack Grey	3701 2000	2005 lb. Bag	1	2005 \$ 1,592.14
15 Premium Multi-Mastic Adhesive White	15 PM1	1 gal. Can	120	1550 \$ 43.20
15 Premium Multi-Mastic Adhesive White	15 MM3.5	3-1/2 gal. Pail	48	2354 \$ 61.06
1776 Grout Admix w/ Micro Ban	1776 GH47	47 oz.	288	1106 \$ 23.94
1776 Grout Admix w/ Micro Ban	1776 GH5	5 Gal.	36	1634 \$ 231.18
•Latapoxy Spot Bonding Adhesives				
Latapoxy 300 Adhesive	300 2	2 lb. Unit	48	1442 \$ 254.78
Latapoxy 210 Adhesive Double Unit / Gray	GRAY 210L	Unit	27 pc/ct	2025 \$ 257.06
Latapoxy 210 Adhesive Single Unit / White	WHT 210L	Unit	48 pc/ct	1824 \$ 196.72
310 Epoxy A&B	310 Epoxy	1/2 Lit. Unit	320st/ct	850 \$ 65.26
310 Rapid Epoxy A&B	310 Repoxy	1/2 Lit. Jar	320st/ct	850 \$ 87.64
Latapoxy 310 Rapid	310 Rlatapoxy	10 Lit. Unit	40	1570 \$ 724.44
Latapoxy 310	310 Latapoxy	10 Lit. Unit	40	1570 \$ 544.88

•Premium Latex Mortar Bed System

3701 Mortar Admix	3701 MA5	5 gal. Pail	36	1634	\$	238.10
226 Thick Bed Mortar	226 TBM60	60 lb. Bag	56	3344	\$	22.96
209 Floor Mud Grey	209 FM60	60 lb. Bag	56	3344	\$	20.16
4-XLT Grey	4XLT	50 lb. Bag	56	2906	\$	50.30
4-XLT White	WHT 4XLT	50 lb. Bag	56	2906	\$	57.00

•Premium Latex Thin-Set Mortar System

4237 Latex Thin-Set Mortar Additive	4237 5	5 gal. Pail	36	1634	\$	259.32
-------------------------------------	--------	-------------	----	------	----	---------------

•Premium Multipurpose Thin-Set Mortar

255 MultiMax Multipurpose Grey	GRAY 255-40	40 lb. Bag	54	2264	\$	66.00
255 MultiMax Multipurpose White	WHT 255-40	40 lb. Bag	54	2264	\$	73.40
254 Platinum Multipurpose Grey	GRAY 254-50	50 lb. Bag	56	2906	\$	71.56
254 Platinum Multipurpose White	WHT 254-50	50 lb. Bag	56	2906	\$	79.54

•Rapid Multipurpose Thin-Set Mortar

253R Gold Rapid Multipurpose Grey	GRAY 253R25	25 lb. Bag	104	2754	\$	27.82
253R Gold Rapid Multipurpose Grey	GRAY 253R50	50 lb. Bag	56	2906	\$	47.74
253R Gold Rapid Multipurpose White	WHT 253R25	25 lb. Bag	104	2754	\$	32.98
101 Rapid Set Latex	101 RSL5	5 gal. Pail	36	1634	\$	256.54

•Multipurpose Thin-Set Mortar

253 Gold Multipurpose Grey	GRAY 253-50	50 lb. Bag	56	2906	\$	27.98
253 Gold Multipurpose White	WHT 253-50	50 lb. Bag	56	2906	\$	33.72
252 Silver Multipurpose Grey	GRAY 252SILVER	50 lb. Bag	56	2906	\$	22.94
252 Silver Multipurpose White	WHT 252SILVER	50 lb. Bag	56	2906	\$	27.98

•Thin-Set Mortar

317 Floor N' Wall Grey	GRAY 317-50	50 lb. Bag	56	2906	\$	14.50
317 Floor N' Wall White	WHT 317-50	50 lb. Bag	56	2906	\$	20.32

•Specialty Mortar

CG Multipurpose Thinset Grey	GRAY CG-50	50 lb. Bag	56	2850	\$	16.54
CG Multipurpose Thinset White	WHT CG-50	50 lb. Bag	56	2850	\$	21.46

•Premium Latex Thin-Set Mortar Additives

333 Super Flexible Additive	333 SFA5	5 gal. Pail	36	1634	\$	169.34
-----------------------------	----------	-------------	----	------	----	---------------

•Waterproof Membrane

9235 Waterproofing Membrane	9235 MINI	Mini Kit	48	1154	\$	323.70
9235 Waterproofing Membrane	9235 FULL	Full Unit	36st/pa	2498	\$	1,142.10

•Hydro Ban

Hydro Ban	HB 1	1 gal.	120	2255	\$	155.80
Hydro Ban	HB 5	5 gal.	36	2156	\$	652.80
Hydro Barrier	HB 1G	1 gal.	30	1520	\$	106.26
Hydro Barrier	HB 3.5	3.5 gal.	48	2042	\$	263.96
Hydro Ban Bonding 5x5 Tile-In Drain ABS Flange	HB LTD5ABS		45	157.5	\$	215.66
Hydro Ban Bonding 5x5 Tile-In Drain PVC Flange	HB LTD5PVC		45	157.5	\$	215.66
Hydro Ban Bonding Drain 5x5 Brushed SS ABS Flange	HB 05BSABS		45	180	\$	175.82
Hydro Ban Bonding Drain 5x5 Polished SS ABS Flange	HB 05PSABS		45	180	\$	205.42
Hydro Ban Bonding Drain 5x5 Brushed SS PVC Flange	HB 05BS		45	180	\$	175.82
Hydro Ban Bonding Drain 5x5 Polished SS PVC Flange	HB 05PS		45	180	\$	205.42
Hydro Ban Preformed Niche 8x8 Soap Dish	HB 0808S		180	300	\$	86.38
Hydro Ban Preformed Niche 8x6 & 8x12 Narrow Combo	HB 0812NC		180	570	\$	111.08
Hydro Ban Preformed Niche 12x12 Square	HB 1212S		180	510	\$	95.66
Hydro Ban Preformed Niche 12x6 & 12x12 Wide Combo	HB 1212WC		180	780	\$	111.08
Hydro Ban Preformed Niche 12x20 Mega	HB 1220M		180	780	\$	111.08
Hydro Ban Preformed Seat 16x16 Convex	HB 1616C		8	64	\$	215.96
Hydro Ban Preformed Seat 16x16 Triangle	HB 1616T		8	64	\$	197.44
Hydro Ban Preformed Seat 23x23 Triangle	HB 2323T		4	56	\$	268.40
Hydro Ban Presloped Shower Pan 38x66 ABS Off-Center Drain	HB 3866ABS		5	225	\$	1,080.20
Hydro Ban Presloped Shower Pan 48x48 ABS Off-Center Drain	HB 4848ABS		5	200	\$	725.42
Hydro Ban Presloped Shower Pan 48x60 ABS Off-Center Drain	HB 4860ABS		5	250	\$	1,080.20
Hydro Ban Presloped Shower Pan 36x48 ABS Center Drain	HB 3648ABS		5	175	\$	662.78
Hydro Ban Presloped Shower Pan 36x60 ABS Center Drain	HB 3660ABS		5	200	\$	845.74
Hydro Ban Presloped Shower Pan 38x66 PVC Off-Center Drain	HB 3866PVC		5	225	\$	1,080.20
Hydro Ban Presloped Shower Pan 48x48 PVC Off-Center Drain	HB 4848PVC		5	200	\$	725.42
Hydro Ban Presloped Shower Pan 36x48 PVC Center Drain	HB 3648PVC		5	175	\$	662.78
Hydro Ban Presloped Shower Pan 36x60 PVC Center Drain	HB 3660PVC		5	200	\$	845.74
Hydro Ban Presloped Shower Pan 48x60 PVC Center Drain	HB 4860PVC		5	250	\$	1,080.20
Hydro Ban Linear Tile Drain 24" Brushed SS	HB 6524BS		56	504	\$	681.62
Hydro Ban Linear Tile Drain 32" Brushed SS	HB 6532BS		56	560	\$	780.34
Hydro Ban Linear Tile Drain 36" Brushed SS	HB 6536BS		56	616	\$	862.24
Hydro Ban Linear Tile Drain 48" Brushed SS	HB 6548BS		56	672	\$	924.86
Hydro Ban Linear Tile Drain 60" Brushed SS	HB 6560BS		56	840	\$	1,265.90
Hydro Ban Linear Tile Drain 24"	HB 6524TI		56	504	\$	771.02
Hydro Ban Linear Tile Drain 32"	HB 6532TI		56	560	\$	830.92
Hydro Ban Linear Tile Drain 36"	HB 6536TI		56	616	\$	880.58
Hydro Ban Linear Tile Drain 48"	HB 6548TI		56	672	\$	976.84
Hydro Ban Linear Tile Drain 60"	HB 6560TI		56	840	\$	1,358.66

	LB / PC	PC / CT	PRICE
PRODUCTS, SIZES, CODES & PRICING			
NAMES (colors)			
Sanded Grout 1524 Natural Grey	25	104	\$ 19.38
Sanded Grout 1500	25	104	\$ 24.12
Unsanded Grout 1644 Bright White	8	44	\$ 15.44
Unsanded Grout 1644 Bright White	25	104	\$ 24.02
Unsanded Grout 1600	8	44	\$ 21.96
Unsanded Grout 1600	25	104	\$ 36.10
Permacolor Grout 2500	25	104	\$ 48.26
Spectralock Full Part C	9	4	\$ 31.48
Spectralock Mini Part C	2.5	4	\$ 8.40
Spectralock 2000 IG Liquid Only #4	16	56 pc/plt	\$ 519.54
Spectralock 2000 IG Liquid Only #2	10.5	48 pc/plt	\$ 241.66
Spectralock 2000 IG Pail Kit #2	29	48 pc/plt	\$ 416.48
Spectralock Part D Dazzle & Mother of Pearl		2	\$ 43.32
Spectralock Part D Glow in the Dark	4.5 oz.	2	\$ 97.68
Commercial SP PROCPRM	14	44 pc/plt	\$ 325.00
Full SP FULLPRM	6	80 pc/plt	\$ 141.32
Mini SP MINIPRM	5	45 pc/plt	\$ 43.42
Caulk Sanded & Unsanded 7100	10.5 oz.	6	\$ 9.92
Latasil 6200	10.3 oz	6	\$ 26.40

See next page for grout colors

Laticrete Grout Colors

•Please refer to the Laticrete Grout Chart for color availability in each unit.

- | | | |
|-------------------|----------------------|--------------------|
| 03 Silk | 41 Kashmir | 59 Espresso |
| 16 Siltstone | 42 Platinum | 60 Dusty Grey |
| 17 Marble Beige | 43 Chocolate Truffle | 61 Parchment |
| 18 Sauterne | 44 Bright White | 66 Chestnut Brown |
| 22 Midnight Black | 45 Raven | 67 Autumn Green |
| 23 Antique White | 46 Quarry Red | 78 Sterling Silver |
| 24 Natural Grey | 50 Sea Glass | 81 Butter Cream |
| 27 Hemp | 52 Toasted Almond | 85 Almond |
| 30 Sand Beige | 53 Twilight Blue | 88 Silver Shadow |
| 34 Sand Stone | 55 Tawny | 89 Smoke Grey |
| 35 Mocha | 56 Desert Khaki | 90 Light Pewter |
| 38 River Rock | 57 Hot Cocoa | 91 Slate Grey |
| 39 Mushroom | 58 Terra Cotta | 92 Saltillo |
| 40 Latte | | |

SKU	SIZE	LBS / PC	PC / CT	LBS / CT	CT / PLT	PRICE
-----	------	----------	---------	----------	----------	-------

PRODUCTS, SIZES, CODES & PRICING

NAMES (colors)

•COMPOSEAL (sold by the Linear Foot)

Shower Pan 30 Blue 100 LF / Roll	3048	4x100	125	1			\$ 5.86
Shower Pan 40 Blue 100 LF / Roll	4048	4x100	125	1			\$ 6.50
Shower Pan 30 Blue 100 LF / Roll	3060	5x100	125	1			\$ 7.32
Shower Pan 40 Blue 100 LF / Roll	4060	5x100	125	1			\$ 8.14
Shower Pan 30 Blue 100 LF / Roll	3072	6x100	125	1			\$ 8.78
Shower Pan 40 Blue 100 LF / Roll	4072	6x100	125	1			\$ 9.76

•Protecto Wrap

Membrane	AFM 12	12"x75' Roll	27	3	80	10	\$ 172.30
Membrane	AFM 36	36"x75' Roll	80	1	80	30	\$ 516.48
Waterproofing Membrane	AFM 36WM	36"x75' Roll	80	1	80	30	\$ 567.40
Crack Prevention Kit*	CP KIT25	12"x25' Roll		9	108		\$ 74.36
Crack Supression Kit*	CS KIT	12"x75' Roll	4.5	4	18	18	\$ 223.08
Mastic	MAS 10.5	10.5 oz Tube		36	14		\$ 15.04
Water Based Primer	6000 WBP-1	1 Gal.		4	34		\$ 77.08
Water Based Primer	6000 WBP-16	16 oz.		9	34		\$ 19.92
Whisper Mat	GRCS WHISPMAT	36"X40' Roll		16	70		\$ 322.00
Exterior Primer	80 EP-1	1 Gal.		4	38		\$ 64.88
Exterior Primer	80 EP-5	5 Gal.		1	57		\$ 261.42

*Contains #6000 Primer and Knife

•TXI

Type 1 Portland Cement Gray	GRAY PC47	47	47	1	47	64	\$ 14.90
Type 1 Portland Cement Gray	GRAY PC94	92.5	92.5	1	92.5	35	\$ 23.02
Sakrete Type S Mortar Mix Gray	GRAY SMM80	80	80	1	80	42	\$ 10.16
Sakrete Sandmix	SM S80	80	80	1	80	42	\$ 10.44

SKU	SIZE	LBS / PC	PC / CT	LBS / CT	CT / PLT	Price
-----	------	----------	---------	----------	----------	-------

PRODUCTS, SIZES, CODES & PRICING

NAMES (colors)

•Mapei

Aqua Defense	AD 1	1 Gal.	13.5	4	54	36	\$ 103.06
Aqua Defense	AD 5	5 Gal.	59	1	59	36	\$ 509.86
Mapelastc 400 Kit (with reinforcing fabric)	MLASTI	5 Gal.	62	1	62	24	\$ 771.96
Mapelastc HPG	MESH328	3.25'x328' Roll	88			10	\$ 552.98
Mapelastc HPG	HPG-1	1 Gal.	13.25	4	53	36	\$ 71.40
Mapelastc HPG	HPG-5	5 Gal.	63	1	63	36	\$ 274.22
Mapelastc SM Primer	PRIMERSM	1 Gal.	8.75	4	35	144	\$ 28.82
Mapelastc SM Primer	PRIMERSM5	5 Gal.	45	1	45	36	\$ 101.76
Fiber Mesh for Mapelastc	MESH375	3'x75' Roll	1	5	5	96	\$ 159.84
Reinforcing Fabric for Mapelastc 400 & Aqua Defense	RF675	6"x75' Roll	4	8	32	120	\$ 28.28
Reinforcing Fabric for Mapelastc 400 & Aqua Defense	RF3875	38"x75' Roll	5	1	5	120	\$ 122.96
Mapeband Coving Roll	PRP-C	3"x163' Roll	5	1	5	5	\$ 421.80
Mapeband Drian Flashing	PRP-315D	13.5x13.5		1	1	24	\$ 50.86
Planiseal Easy Subfloor Sealer	EASY	4 Gal.	44	1		36	\$ 132.04
Mapeguard 2	MGUARD	39.4"x68.6'	42	1	42	20	\$ 445.62

•Topping & Repair Systems

Topecem Premix	TOPECEM	40 lb	40	4	40	56	\$ 28.34
Mapecem Rapid Set Binder	MAPECEM	44 lb	44	1	44	56	\$ 44.82
Mapecem Premix	MAPPRE	40 LB	40	1	40	60	\$ 29.12
Mapelath 27"x75' Roll	MAPELATH	27"X75'	22	1	22	18	\$ 251.30

PRODUCTS, SIZES, CODES & PRICING

NAMES (colors)

•Self Leveling Underlayments

Nova Plan Easy	PEASY	56	50	2800	\$	47.90
Ultraplan 1 Plus	UPLAN1+	56	50	2800	\$	56.94
Ultraplan Easy	UPEASY	56	50	2800	\$	64.48
Ultraplan M20 Plus	UPLANM20+	56	50	2800	\$	64.28

•Priming Systems

Ultraprime Latex Primer 1 Gal	UPL-1	144	8.75	1260	\$	35.48
Primer L	UPL-5	36	48	1728	\$	160.32
Ultraprime WE Epoxy Primer 2 Gal	UPWE-2	36	21	756	\$	198.26
Primer T	PRIMERT	72	10	720	\$	133.56

•Patching Compound

Plani Patch	PATCH25	100	25	2500	\$	31.06
Plani Patch Plus Additive 1 Gal	PATCH-Gal	144	9.23	1330	\$	37.96

•Traditional Dry-Set Mortar Systems

Kerabond Gray	KB-50	56	50	2800	\$	23.32
Kerabond White	KB-50WT	56	50	2800	\$	28.22
Keraset Gray	KSETGR50	56	50	2800	\$	16.60
Keraset White	KSETWT50	56	50	2800	\$	21.42
Keraflor Gray	KFLOGR50	56	50	2800	\$	13.80
Keraflor White	KFLOWH50	56	50	2800	\$	18.58
Keraply 2 Gal	KPLY2	72	18	1296	\$	38.58
Keraply 5 Gal	KPLY5	36	45	1620	\$	90.48
Keraply 55 Gal	KPLY55	4	495	1980	\$	946.66
Keracrete 5 Gal Pail	KC-5	36	45	1620	\$	97.46
Glass Block Mortar	GBM-50	56	50	2800	\$	32.78
Ker Gray Mortar	KER111G	56	50	2800	\$	16.78
Ker White Mortar	KER111W	56	50	2800	\$	21.48

•High Performance Flexible Mortar Systems

Keralastic 2 Gal	KL-2	72	18	1296	\$	74.08
Keralastic 5 Gal	KL-5	36	45	1620	\$	154.64
Keralastic 55 Gal	KL-55	4	498	2042	\$	1,578.54
Keralastic System Kit White	KL-WT	60	35	2100	\$	89.48

•High Performance Flexible Mortar Systems

Grani Rapid Gray	GRAPID-GR	56	50	2800	\$	53.40
Grani Rapid White	GRAPID-W	56	46	2800	\$	65.16
Grani Rapid Liquid 2 Gal	318-2	72	18	1296	\$	81.46
Grani Rapid Liquid 55 Gal	318-55	4	483	1932	\$	2,021.00
Ultra Lite Gray	UL-25	70	25	1750	\$	54.32

•Polymer Modified Mortars

Adesilex P10 Glass Tile Mortar	AP10	56	43	2408	\$	20.80
Ultra Flex Rapid Set Gray	KQM25	100	25	2500	\$	26.60
Ultra Flex Rapid Set Gray	KQM50	56	50	2800	\$	49.22
Ultra Flex Rapid Set White	KQM50-WT	56	50	2800	\$	56.30
Ultra Flex I Gray	UFLXGR-1	56	50	2800	\$	25.78
Ultra Flex I White	UFLXWT-1	56	50	2800	\$	29.52
Ultra Flex II Gray	UFLEXGR	56	50	2800	\$	32.48
Ultra Flex II Gray	UFLEXGR25	80	25	2588	\$	21.24
Ultra Flex II White	UFLEXWHT	56	50	2800	\$	38.92
Ultra Flex II White	UFLEXWT25	80	25	2588	\$	24.92
Ultra Flex III Gray	UFLXGR-3	56	50	2800	\$	64.54
Ultra Flex III White	UFLXWT-3	56	50	2800	\$	72.24
Ultra Flex LFT Gray	UF-LFT	56	50	2800	\$	47.38
Ultra Flex LFT White	UF-LFT	56	50	2800	\$	51.38
Ultra Flex LFT Rapid White	UF-LFTRS	56	50	2800	\$	74.28

•Full Contact Mortars

Ultra Contact Gray	UCGRAY50	56	50	2800	\$	36.48
Ultra Contact White	UCWHT50	56	50	2800	\$	43.34
Ultra Contact Rapid Set Gray	P4G	56	50	2800	\$	46.78
Ultra Contact Rapid Set White	P4W	56	50	2800	\$	56.26

•Specialty Mortars

Planicrete W 1.8 Gal	PCRETEW2	64	28	1792	\$	272.80
Planicrete AC 1 Gal	PCAC-1	144	8.75	1310	\$	29.44
Planicrete AC 5 Gal	PCAC-5	36	45	1670	\$	117.58

•Mastics

Type I Contractor Grade 1 Gal	UM-1-1	144	12.25	1764	\$	32.72
Type I Contractor Grade 1 Qt	UM-1-QT	432	3.2	1382	\$	11.48
Type I Contractor Grade 3.5 Gal	UM-1-3.5	42	46	1932	\$	71.64
Ker 909	909 KER	42	43	1806	\$	57.88

LB / PC

PC / PLT

PRICE

PRODUCTS, SIZES, CODES & PRICING

NAMES (colors)			
Keracolor Sanded	25	100	\$28.34
Keracolor Unsanded	10	128	\$18.34 level 1 / 23.38 level 2
Keracolor Unsanded	25	80	\$30.92 level 1 / \$40.14 level 2
Opti Color Part C Powder	9	128	\$28.68
Opti Color Part A&B Small Unit	2	96	\$42.60
Opti Color Part A&B Medium Unit	4	64	\$139.08
Opti Color Part A&B Large Unit	15	54	\$320.10
Ultracolor Plus	10	128	\$27.98
Ultracolor Plus	25	80	\$46.66
Caulk Sanded 10.5 oz.	4 pcs / ct	5 lbs / ct	\$14.90
Caulk Unsanded 10.5 oz.	4 pcs / ct	5 lbs / ct	\$8.86 level 1 / \$14.88 level 2
Kerapoxy 410 Kit 3 Gal	36	48	\$249.46
Kerapoxy Grout 1 QT	3.67	216	\$41.24
Kerapoxy Grout 1 GAL	13	64	\$111.00
Kerapoxy Grout 2 GAL	25	48	\$202.84

All Kerapoxy is non-stock/special order. Please allow 2 weeks for delivery.

•Mapei Grout Colors

00 White	11 Sahara Beige	35 Navajo Brown	49 Light Almond
01 Alabaster	13 French Vanilla	37 Terre Cotta	50 Magnolia
02 Pewter	14 Buscuit	38 Avalanche	74 Camel
04 Bahama Beige	15 Bone	39 Ivory	77 Frost
05 Chamois	16 Malt	41 Irish Cream	79 Cocoa
06 Harvest	19 Pearl Gray	42 Mocha	93 Warm Gray
07 Chocolate	24 Summer Tan	44 Pale Umber	94 Straw
09 Gray	27 Silver	46 Slate	96 Sand
10 Black	29 Green Tea	47 Charcoal	98 Waterfall

•Please refer to the Mapei Grout Chart for color availability in each unit.

SKU	SIZE	SF / PC	LB / PC	PC / PLT	PLT / TL	Price
-----	------	---------	---------	----------	----------	-------

PRODUCTS, SIZES, CODES & PRICING

NAMES (colors)

James Hardy

Hardy Board	HARDYEZ	3x5x1/4	15	32.20	60	25	\$ 21.54
Hardy Board	G2 HARDY	3x5x1/2	15	41.25	50	21	\$ 24.90
Hardy Board	HARDY484	4x8x1/4	32	66	50	15	\$ 47.68

United States Gypsum

Durock	172964	3x5x1/2	15	48	50		\$ 23.52
Durock	172951	4x4x1/2	16	39	40		\$ 22.32
Fiberrock	60085	4x4x1/4	16	25	60	29	\$ 18.00
Fiberrock	60088	3x5x1/2	15	40	50	40	\$ 21.10
Fiberrock	61002	3x5x1/4	15	24	60		\$ 16.86

Noble Company

Permabase Ultra	CB 2314	3x5x1/4	15	28.32	50		\$ 22.18
Permabase Flex	CB 4844	4x8x1/2	32	2.48	30		\$ 74.10
Permabase	CB 3612	3x5x1/2	15	46.12	50		\$ 22.60

SKU	UNIT	PC / CT	LB / CT	Price
-----	------	---------	---------	-------

PRODUCTS, SIZES, CODES & PRICING

NAMES (colors)

Enhancer Pro (solvent based)	D124 46641	Quart	12	24	\$ 101.72
Heavy Duty Exterior Stone & Masonry Sealer	D124 46717	2 oz	12	2	\$ 5.14
Heavy Duty Exterior Stone & Masonry Sealer	D124 46720	Quart	12	23	\$ 38.60
Heavy Duty Exterior Stone & Masonry Sealer	D126 12261	Gallon	4	28	\$ 115.20
Stone & Tile Cleaner (daily - ready to use)	D124 46769	2 oz	12	2	\$ 4.44
Stone & Tile Cleaner (daily - ready to use)	D144 36698	Quart	6	14	\$ 16.18
Oil Stain Remover	D124 46896	2 oz	6	3	\$ 9.16
Klenz All (Alkaline Cleaner-Concentrated)	D124 46928	2 oz	12	2	\$ 4.44
Klenz All (Alkaline Cleaner-Concentrated)	D144 35661	Quart	6	15	\$ 19.88
Grout Release	D126 12458	Gallon	4	38	\$ 42.62
Restore (Acidic Cleaner-Concentrated)	D126 14286	2 oz	12	2	\$ 4.44
Restore (Acidic Cleaner-Concentrated)	D144 46083	Quart	6	16	\$ 19.80
Heavy Duty Coating Stripper	D133 89043	2 oz	12	2	\$ 4.44
Heavy Duty Coating Stripper	D146 67592	Quart	6	14	\$ 58.06
Grout Sealer	D146 08463	2 oz	12	2	\$ 5.14
Grout Sealer	D144 43446	24 oz	6	10	\$ 24.64
Grout Sealer	D146 08504	Gallon	4	37	\$ 80.90
Revitalizer Citrus (daily clean - ready to use)	D146 08345	2 oz	12	2	\$ 4.44
Revitalizer Citrus (daily clean - ready to use)	D146 08351	24 oz	12	21	\$ 19.42
Sanitizer	D148 06150	24 oz	6	11	\$ 13.22
Sanitizer	D148 06161	Gallon	4	36	\$ 43.54
Soap Scum Remover (natural stone)	D148 22742	24 oz	6	10	\$ 16.74
Mold & Mildew Stain Remover (natural stone)	D148 22797	24 oz	6	11	\$ 16.74
Stain Protecting Grout Additive	D148 22821	27 oz	6	38	\$ 33.52

SKU	UNIT	PC / CT	LB / CT	PRICE
-----	------	---------	---------	-------

PRODUCTS, SIZES, CODES & PRICING

NAMES (colors)				
Stain Protecting Grout Additive	D148 22832	67 oz	4	47 \$ 67.06
Bullet Proof Sealer (water based)	D149 24207	2 oz	12	2 \$ 5.14
Bullet Proof Sealer (water based)	D149 24218	Pint	12	12 \$ 55.14
Bullet Proof Sealer (water based)	D149 24230	Quart	12	29 \$ 84.38
Bullet Proof Sealer (water based)	D149 24240	Gallon	4	37 \$ 241.90
Heavy Duty Sealer (water based)	D149 24278	2 oz	12	2 \$ 5.14
Heavy Duty Sealer (water based)	D14924289	Pint	12	12 \$ 37.70
Heavy Duty Sealer (water based)	D149 24301	Quart	12	29 \$ 57.84
Heavy Duty Sealer (water based)	D149 24311	Gallon	4	37 \$ 170.02
Semi Gloss Finishing Sealer (water based)	D149 24574	Quart	6	14 \$ 34.22
High Gloss Finishing Sealer (water based)	D149 24625	Quart	6	14 \$ 34.14

MARAZZI

TILE & STONE

Sales Service Center Locations

Anaheim, CA

1340 S. State College Blvd
Anaheim, CA 92806
714.956.7565
714.956.7586 fax
anaheim@marazzitile.com

Austin, TX

3101 Industrial Terrace
Suite 106
Austin, TX 78758
512.835.4500
521.835.9575 fax
austin@marazzitile.com

Dallas, TX

2250 LBJ Freeway
Suite 200
Dallas, TX 75234
972.728.7000
972.728.7019 fax
dallas@marazzitile.com

Denver, CO

12435 E. 42nd Ave
Suite 10, Bldg F
Denver, CO, 80239
303.375.8453
303.375.8973 fax
denver@marazzitile.com

Fort Worth, TX

6313A Airport Freeway
Fort Worth, TX 76117
817.222.0510
817.222.1510 fax
ftworth@marazzitile.com

Houston, TX

8787 Clay Road
Suite 100
Houston, TX 77080
713.939.9500
713.939.8198 fax
houston@marazzitile.com

Houston South, TX

3440 S. Sam Houston Pkwy E
Suite 100
Houston, TX 77047
713.734.4677
713.733.1361 fax
shouston@marazzitile.com

Las Vegas, NV

6975 South Decatur Blvd
Suite 100
Las Vegas, NV 89118
702.248.3040
702.248.3045 fax
lasvegas@marazzitile.com

Oklahoma City, OK

3100 Thomas Road
Oklahoma City, OK 73179
405.680.9552
405.686.0370 fax
okc@marazzitile.com

Phoenix, AZ

2115 S. 11th Ave, Suite 170
Phoenix, AZ 85007
602.253.5551
602.253.5559 fax
phoenix@marazzitile.com

Salt Lake City, UT

2940 South 300 West, Unit E
Salt Lake City, UT 84115
801.467.8453
801.467.8469 fax
saltlakecity@marazzitile.com

San Antonio, TX

1050 Arion Parkway
Suite 100
San Antonio, TX 78216
210.545.9101
210.545.9162 fax
sanantonio@marazzitile.com

San Diego, CA

9020 Activity Road, Suite B
San Diego, CA 92126
858.547.8453
858.695.8453 fax
sandiego@marazzitile.com

Corporate Office

359 Clay Road
Sunnyvale, TX 75182
www.marazzitile.com

TERMS AND CONDITIONS

Return policy

- All returns must have a pre-approved **Return Authorization Form** included with the shipment. Contact your local service center or sales representative for the form.
- Returns will only be accepted within **30 days** of the original invoice date and will be subject to a **20% restocking fee**.
- Returns will only be accepted in original unopened packaging
- Customer is responsible for all freight and handling charges associated with the return
- Due to expiration dates and lot differences, no returns will be accepted for natural stones, setting materials, grouts and/or special order items
- Damaged material must be reported within 72 hours of receipt.
- Returns will not be accepted on discontinued items
- Any deviation from this policy must be approved by Management
- **Effective May 15, 2011 a 2.5% fuel surcharge will be applied to each invoice.**

Limited Warranty

Marazzi USA warrants that its first choice ceramic tile is manufactured according to ANSI A137.1-1988 and meets or exceeds these requirements. If a tile is proven to contain a manufacturing defect, Marazzi USA will supply, free of charge, material of compatible color and shade as determined by Marazzi USA. **Labor charges are expressly excluded from this warranty.**

Marazzi USA makes no warranty as to the suitability of its tile for a particular installation. Marazzi USA does not warrant that its glazed ceramic or porcelain tile will not scratch, chip or show signs of wear.

Marazzi USA or the Marazzi USA Distributor must be notified of any claims or defects as soon as reasonably possible, but in any case, **not later than one year** after the goods have been delivered by Marazzi USA. This notification must be in writing or sent by certified mail. Claims concerning shade, appearance, caliber, finish or obvious defects in first choice production must be communicated before the tile is installed. **No claims will be accepted for tile already installed or for defects in other than first choice material.**

Marazzi USA specifically excludes liability for consequential or incidental damages, except where exclusion of consequential damage is not permitted by state law.

This limited warranty shall constitute the full extent of Marazzi USA's liability and is in place of all other warranties, express or implied, including the implied warranty of merchantability and the implied warranty of fitness for a particular purpose.

This warranty and the exclusion of implied warranties of merchantability and fitness for a particular purpose do not affect the special warranty provided by the Marazzi Group on Marazzi Enduro® products.

In addition to the items in our catalog, we offer an extensive non-stocking and special order program. We also stock a complete line of tools. Please contact your local Marazzi Tile & Stone Sales Service Center or your Sales Representative for details.

Pricing Discount Structure:

Standard _____ Natural Stone _____ Setting Materials _____